

# Supplementary Information

## **Feasible Alternatives to Green Growth**

Simone D'Alessandro\*, André Cieplinski,  
Tiziano Distefano and Kristofer Dittmer

\*Corresponding Author's e-mail: [simone.dalessandro@unipi.it](mailto:simone.dalessandro@unipi.it)

# Contents

<b>1</b>	<b>Supplementary Methods</b>	<b>4</b>
1.1	Data . . . . .	4
1.2	Population . . . . .	5
1.3	Input–Output, GDP and International Trade . . . . .	6
1.4	Households Income . . . . .	10
1.5	Wealth distribution, financial income, and portfolio choice . . . . .	17
1.6	Innovation: labour productivity and energy efficiency . . . . .	20
1.7	Employment, wages and working time . . . . .	22
1.8	Households Consumption . . . . .	26
1.9	Investments, prices and profits . . . . .	28
1.10	Energy and greenhouse gas emissions . . . . .	32
1.11	Public sector . . . . .	37
1.12	Stock-Flow Matrices . . . . .	41
<b>2</b>	<b>Supplementary Results</b>	<b>43</b>
2.1	Summary of simulated policies . . . . .	43
2.2	Individual policy results . . . . .	46
2.2.1	Baseline comparison . . . . .	48
	<b>Supplementary References</b>	<b>51</b>

## List fo Supplementary Figures

1	Illustration of Population Module . . . . .	6
2	Illustration of Output and GDP Module . . . . .	9
3	Illustration of Households' Disposable Income . . . . .	16
4	Illustration of the Financial Assets Module . . . . .	20
5	Three-steps innovation dynamic . . . . .	22
6	Illustration of the Labour Module . . . . .	25
7	Private consumption distribution . . . . .	26
8	Illustration of the Consumption Module . . . . .	27
9	Illustration of the Investment Module . . . . .	31
10	Illustration of the Prices and Profits Module . . . . .	32
11	Structural decomposition analysis of the total GHG emissions . . . . .	36
12	Public consumption distribution . . . . .	38
13	Scenario analysis: socio-economic indicators . . . . .	46
14	Scenario analysis: socio-environmental indicators . . . . .	47
15	Share of energy sources . . . . .	48

## List fo Supplementary Tables

1	Population groups and skill distribution (2014) . . . . .	5
2	NACE (Rev.2) classification in the <i>Eurogreen</i> model . . . . .	7
3	Households output in France (2014, million euros) . . . . .	8
4	Tax schedule for taxable annual income . . . . .	11
5	General French government expenditure on social protection (2014) . . . . .	14
6	List of income sources for workers and capitalists . . . . .	16
7	Distribution of financial assets across socio-economic groups (2014) . . . . .	17
8	Set of new technologies . . . . .	21
9	Labour force by skill (2014) . . . . .	23
10	Employment by skill under the baseline scenario . . . . .	25
11	Households consumption distribution . . . . .	27
12	Shares of energy sources on <i>TPES</i> and <i>EPG</i> (2014) . . . . .	33
13	Energy mix by industry (2014) . . . . .	34
14	Energy use distribution by source . . . . .	35
15	Government consumption distribution . . . . .	37
16	Government balance: revenue and expenditure sources . . . . .	39
17	Aggregate Balance sheet . . . . .	41
18	Transaction Flow Matrix . . . . .	42
19	Summary of Individual policies . . . . .	44
20	Summary of Policy Mixes . . . . .	45
21	Selected indicators from the <i>Eurogreen</i> baseline scenario and EU long-term projections . . . . .	49

# 1 Supplementary Methods

This section presents the *Eurogreen* model in detail. It lists the data sources used and the equations that explain the causal relations modelled. Each subsection below presents a module of *Eurogreen*.

## 1.1 Data

The *Eurogreen* model required a vast effort in collecting, merging, analysing, and synthesizing the necessary amount of data to calibrate the parameters and the initial conditions, to underpin the several behavioral assumptions, and to verify the robustness of the simulated results. For these reasons, we gather data from alternative databases, depending on availability. In particular:

- *World Input-Output Database (WIOD)*,<sup>1</sup> allowed us to aggregate industries into our productive sectors. It is based on the NACE Rev.2 classification.<sup>2</sup> Data are provided from 2000 to 2014 at current euro prices (i.e., nominal values).
- *Eurostat*: provides annual energy balances from which we recovered the annual total primary energy supply (TPES), by industry, and the distribution and composition of sources used for the energy and electricity production.<sup>3</sup> Additionally, it provides data on greenhouse gas emissions by (the NACE Rev.2) sectors.<sup>4</sup> When information on energy or air pollution were not available, we integrated the gaps with data from the International Energy Agency (IEA),<sup>5</sup> We also obtained data on Government expenditure from Eurostat’s COFOG database.<sup>6</sup>
- *EU-Klems Project*:<sup>7</sup> provides data on labour composition, hourly wages and working hours by skill and industry. Data on labour force supply were collected from Eurostat.
- *OECD.Stat*: provides data on French social benefits and tax systems.<sup>8</sup>
- The French national statistics office INSEE reports demographic data, completed with Eurostat when necessary.<sup>9</sup>

In what follows we describe the dynamic equations behind each building block, as described in Section 1.B of the main text. The full list of equations and the causal links among all the variables of the model are available at: [https://people.unipi.it/simone\\_dalessandro/eurogreen-model/](https://people.unipi.it/simone_dalessandro/eurogreen-model/). In equations, the time index  $t$  denotes the current year,  $t - 1$  the immediately preceding period,  $t - 2$  the one before that, and so on. The first simulated period is the year 2014.

---

<sup>1</sup>We opted for the last freely-available version “Release 2016”, see <http://www.wiod.org/database/wiots16>.

<sup>2</sup>See <http://ec.europa.eu/eurostat/ramon/nomenclatures>.

<sup>3</sup>See <https://ec.europa.eu/eurostat/web/energy/data/energy-balances>.

<sup>4</sup>See [http://appsso.eurostat.ec.europa.eu/nui/show.do?lang=en&dataset=env\\_air\\_gge](http://appsso.eurostat.ec.europa.eu/nui/show.do?lang=en&dataset=env_air_gge).

<sup>5</sup>See <https://www.iea.org/policiesandmeasures/pams/france/>.

<sup>6</sup>See <https://ec.europa.eu/eurostat/cache/infographs/cofog/>.

<sup>7</sup>See [http://www.euklems.net/project\\_site.html](http://www.euklems.net/project_site.html).

<sup>8</sup>See <http://www.oecd.org/social/benefits-and-wages.htm>.

<sup>9</sup>See <https://www.insee.fr/en/accueil>.

## 1.2 Population

We define four age groups: I. 0–14, II. 15–44, III. 45–64, and IV. 65 years or more. Groups II and III constitute the working-age population.<sup>10</sup> This module includes several *exogenous* parameters to calibrate the population dynamics, such as mortality rate ( $\alpha^-$ ),<sup>11</sup> fertility rate ( $\alpha^+$ ), inter-cohorts flow rate ( $\rho$ ), reproductive lifetime ( $RL$ ), and life expectancy ( $LE$ ). Namely, for  $n \in \{I, II, III, IV\}$  the change in population group  $n$  from year  $t - 1$  to year  $t$  ( $\Delta Pop_{n,t}$ ) is given by:

$$\Delta Pop_{n,t} = (Pop_{II,t} + Pop_{III,t}) \frac{0.5 \cdot \alpha^+}{RL} - Pop_{n,t-1} \cdot (\rho_n^- + \alpha_n^-) + \rho_n^+ Pop_{n-1,t-1} \quad (1)$$

where  $\alpha^+ = 2.11$  is constant (and only for  $n = I$ ),  $RL = 30$  is the number of reproductive years in a lifetime,  $\rho$  is a fraction of survived people who goes to/from ( $\rho_n^-$  and  $\rho_n^+$ , respectively) the next/previous population group. The mortality rate depends on the lifetime expectancy (set to 80 years in the model) with the following values per cohort:  $\alpha_I^- = 0.001$ ,  $\alpha_{II}^- = 0.0005$ ,  $\alpha_{III}^- = 0.00171$ , and  $\alpha_{IV}^- = 0.04$ . The population aged 15 years or over is further divided into three groups (or socio-economic strata) based on the level of educational attainments: low-skill, middle-skill, and high-skill. The low-skill group has lower secondary education or below, corresponding to levels 0-2 of the ISCED 2011 classification. The middle-skill group has an upper secondary or post-secondary non-tertiary education (ISCED 3 and 4). Finally, high-skill individuals are those with tertiary education (ISCED 5-8).<sup>12</sup> Supplementary Table 1 reports the composition of the population by age and skill in France in 2014. The dynamics of labour supply distribution by skills are described in greater detail in section 1.7.

**Supplementary Table 1: Population groups and skill distribution (2014)**

France	L (%)	M (%)	H (%)	L	M	H	Total
Pop. 0+	-	-	-	-	-	-	66,456
Pop. 15+	33.5	40.2	26.3	18,118	21,729	14,263	54,110
Working age 15–64	26.6	43.7	29.7	11,117	18,302	12,457	41,876
Pop. 65+	57.5	27.9	14.6	7,001	3,427	1,806	12,234

Skill levels of the population are divided in low ( $L$ ), medium ( $M$ ) and high ( $H$ ) educational attainment. Values by age group and employment status are in thousands (1,000) of units. Source: Own calculations based on Eurostat.

A simple graphical representation of the population module is presented in Supplementary Figure 1.

<sup>10</sup>Only 4.4% of the resident population aged 65–74 was part of the labour force in 2014 (Eurostat LFS).

<sup>11</sup>Note that the birth rate could be linked to women education; however, we take it an exogenous constant over all the simulation time window.

<sup>12</sup>Note that the Eurostat LFS database does not include the population aged 75 or over. Therefore, to obtain a more complete picture for 2014, we use responses of the 70-74 cohort from 2009, 2004, and 1999 (applying the shares of the 70-74 group of 1999, corresponding to the 85-89 group of 2014, also to the 90+ group of 2014). We make an adjustment for correlations between life expectancy and skill by comparing the skill-shares of the 65-69 cohort of 2009 with the 70-74 cohort of 2014 and applying the implied differential mortality rates once to each of the pre-2014 response groups. This is equivalent to assuming there are no skill-based differences in mortality rates beyond 80 years old.

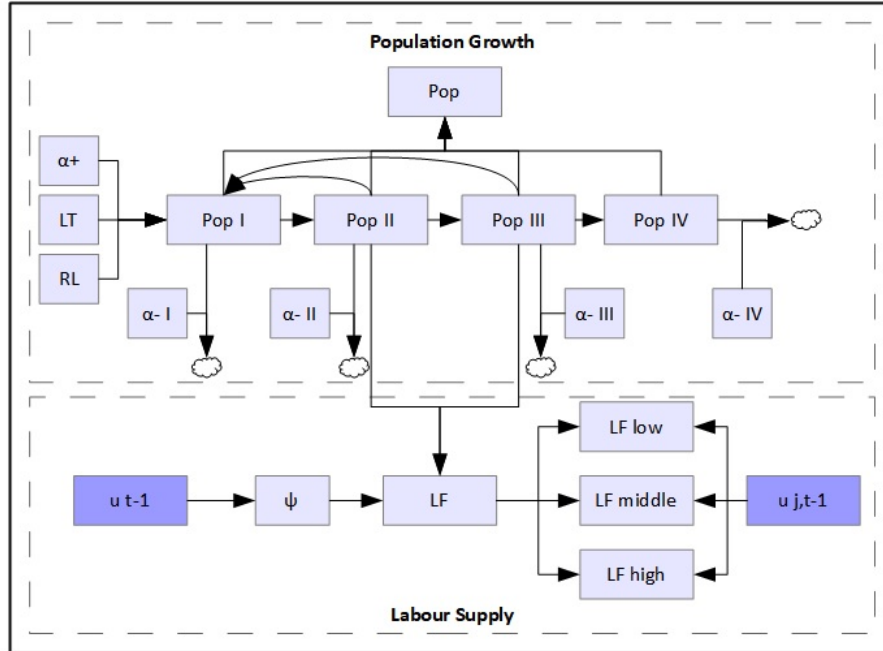

**Supplementary Figure 1: Illustration of Population Module**

The illustration of the population module contains also the laboursupply variables – where  $u_{t-1}$  and  $\psi$  stand for unemployment and participation rate, respectively – as explained in subsection 1.7 (see equation 48). The cloud symbols indicate outflows, in this case mortality. The arrows connecting population groups II and III to group I represent the fact that these two groups are those to which fertility rates are applied as shown in equation 1.

### 1.3 Input–Output, GDP and International Trade

#### Input-Output and GDP

The productive industries in the model trade intermediate goods and services. The input-output “technical coefficients” – i.e. the share of inputs from other industries required per unit of output (both measured in basic prices) in each industry – are calculated for 2014 using the WIOD input-output tables (Timmer et al., 2015) for France in 2014. WIOD matrices are industry-based but adjusted to correspond better with product-based international trade data (Dietzenbacher et al., 2013).<sup>13</sup> The aggregation from NACE Rev.2 industries into the ten industries of our model is summarized in Supplementary Table 2.

We impose some simplifications to aggregate the sectors provided by WIOD into those applied in the model. Construction and real estate service industries are aggregated together in a single sector (n. 6 from Supplementary Table 2).<sup>14</sup> Imputed rents are the main element of the output for own final use of households (Table 3). At 168,078 million euros, they are also a large fraction of the output of the real estate sector which summed up to 300,395 million euros in 2014.

Total private final consumption is given by the sum of final consumption expenditure of households and of non-profit institutions serving households (NPISH). Moreover, whenever final government expenditure (in a given sector  $i$ ) was less than 10% of  $f_i^{HH}$ , it was added to  $f_i^{HH}$  itself. The same rule was applied to imports, so that they were shifted to

<sup>13</sup>Due to these corrections, aggregate output of 2014 is 0.6% lower in the WIOD than in the national accounts. Output varies at the industry level from 4.4% lower ( $I$ ) to 4.3% higher ( $E$ ), though the average discrepancy is of  $\sim 1\%$ .

<sup>14</sup>No special account is taken for the large share of this industry’s activity represented by the imputed rents of owner-occupied dwellings.

Supplementary Table 2: NACE (Rev.2) classification in the *Eurogreen* model

<i>Num.</i>	<b>Name</b>	<i>NACE Rev. 2 code</i>	<b>NACE Rev. 2 description</b>
1	<b>Agriculture</b>	<i>A</i>	Agriculture, forestry and fishing
2	<b>Mining</b>	<i>B</i>	Mining and quarrying
3	<b>Fossil Fuels</b>	<i>C19</i>	Manufacture of coke and refined petroleum products
4	<b>Manufacturing</b>	<i>C (excl. C19)</i>	Manufacturing
5	<b>Electricity and Gas (ELG)</b>	<i>D</i>	Electricity, gas, steam and air conditioning supply
6	<b>Construction</b>	<i>F</i> <i>L</i>	Construction Real estate activities
7	<b>Services</b>	<i>G</i> <i>H</i> <i>I</i> <i>J</i> <i>M</i> <i>N</i> <i>R</i> <i>S</i>	Wholesale and retail trade Transportation and storage Accommodation and food service activities Information and communication Professional, scientific and technical activities Administrative and support service activities Arts, entertainment and recreation Other service activities
8	<b>Finance</b>	<i>K</i>	Financial and insurance
9	<b>Public</b>	<i>E</i> <i>O</i> <i>P</i> <i>Q</i>	Water supply Public administration and defence Education Human health and social work activities
10	<b>Other</b>	<i>T</i>	Activities of households as employers
-	<b>Not included</b>	<i>U</i>	Activities of extraterritorial organizations and bodies

Definition and aggregation criteria of the ten productive sectors in *Eurogreen* model, in accordance with the NACE classification. Column one shows the name of the macro-sectors used in the *Eurogreen* model.

**Supplementary Table 3: Households output in France (2014, million euros)**

NACE Rev.2	Indicator	Households including sole proprietor. (S14)	Non-financial sole proprietorship (S14ANF)
All branches	Output (P1)	436,376	187,974
	Market output (P11)	237,859	187,508
	Output for own final use (P12)	198,517	466
L68A	Imputed rent output (P12)	168,078	–

domestic production with the exception of non-financial services due to the large size of its imports in absolute terms. The industry affected by this shift is  $E$ , with a 7.7% imports-to-domestic-output ratio (also shifted were industries  $D$ ,  $F$ ,  $K$ ,  $L$ ,  $O$ ,  $P$ , and  $Q$ ). To keep domestic industry outputs unchanged, exports are reduced by equivalent amounts. When this would make exports negative (industries  $F$  and  $L$ ), the amount is instead subtracted from gross fixed capital formation. This procedure entails that the economy's degree of openness (i.e., exports plus imports as share of GDP) will be somewhat smaller than the actual value for 2014. At 574,127 million euros, the initial imports results lower than the actual 584,372 million, by about 1.75%; while exports total 557,507 million or  $\sim 2.5\%$  lower than original WIOD data (571,814 million).

The *Eurogreen* model follows the Leontief and the post-Keynesian traditions (Miller and Blair, 2009; Lavoie, 2014) by assuming that the economy is *demand-driven* and that industries are involved in inter-industry trade – both at national and international level – from industry  $i$  to  $i$  ( $Z_{i,i}$ ). We assume that each industry uses labor, capital, and energy as productive factors. Imports in each industry  $i$  are set as a constant fraction ( $\mu_i$ ) of its total output given their observed stability over time (see subsection 1.3 and Supplementary Figure 7). The total output of each industry ( $i$ ) is then given by:

$$y_i = f_i^{dom} + \sum_j Z_{i,i}^{dom} + \chi_i \quad (2)$$

where  $f_i^{dom}$  is the domestic final demand – given by the sum of domestic gross fixed capital formation, domestic private consumption and domestic government expenditure in industry  $i$  –  $Z_{i,i}^{dom}$  is the domestic inter-industry trade, and  $\chi_i$  are the overall exports from industry  $i$  (including intermediate and final goods). Note that the input-output approach allows one to recover the total output by knowing the vector of total final industry demands ( $\mathbf{f}$ ) and the Leontief matrix ( $\mathbf{L}$ ) – obtained from the matrix of technical coefficients ( $\mathbf{A}$ ) – to obtain the vector of total output by industry ( $\mathbf{y}$ ).<sup>15</sup> Namely

$$a_{i,j} = \frac{Z_{i,j}}{X_j}, \quad \forall a_{i,j} \in \mathbf{A} \quad (3)$$

$$\mathbf{L} = (\mathbf{Id} - \mathbf{A})^{-1}, \quad (4)$$

$$\mathbf{y} = \mathbf{L} \cdot \mathbf{f}^{dom} \quad (5)$$

where  $\mathbf{Id}$  is the identity matrix and  $a_{i,j}$  the technical coefficient that compose matrix  $\mathbf{A}$ . This structure allows us to focus on the demand-side to describe the dynamics of industry ( $y_i$ ) and total output ( $\mathbf{Y}$ ) given final demand ( $f$ ). Production is supply constrained by the maximum output of each industry which depends on their total stock of fixed capital (described in Section 1.9). Moreover, as described in subsection 1.6, we model an innovation process that determines (endogenously) the dynamic evolution on the technical coefficients in  $\mathbf{A}$  of the two energy-supplying industries (n. 3 (C19) and 5 (ELG) from Supplementary Table 2).

Another advantage of using the input-output structure is that it represents the national accounts. This ensures a

<sup>15</sup>Although changes in inventories are not modelled, they are considered in the calculation of technical coefficients. For the calculation of technical coefficients, the output of the sector n.6 ( $F+L$  from Supplementary Table 2) is reduced by the amount of imputed rents, which show up as final consumption of households. The corresponding amount is also subtracted from the value added of the same sector.



correct computation of the gross domestic product, both from the demand- ( $GDP^d$ ) and supply- ( $GDP^s$ ) side. Namely:

$$GDP^d = f^{dom} - \sum_i \sum_j Z_{i,j}^{imp} + TLS^f, \quad (6)$$

$$GDP^s = \sum_i VA_i + TLS^f + \sum_i TLS^i, \quad (7)$$

$$GDP^d \equiv GDP^s, \quad (8)$$

where  $f^{dom}$  is the overall domestic final demand,  $\sum_j Z_{i,j}^{imp}$  are the total imports of French industries from abroad,  $\sum_i VA_i$  is the total value added (profits plus wages),  $TLS^f$  and  $TLS^i$  are the total amount of tax less subsidies from the final demand and by industry, respectively. The main variables in the determination of output and GDP are illustrated in Supplementary Figure 2.

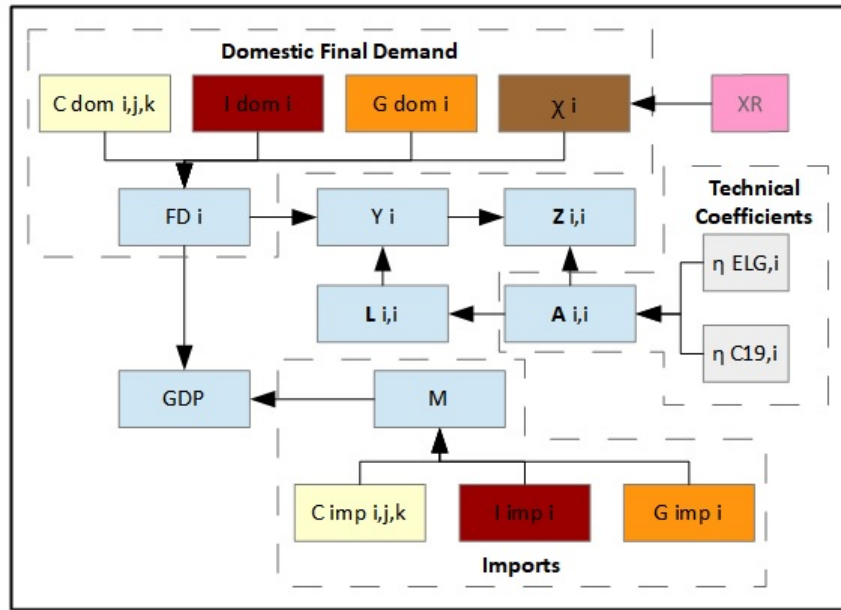

Supplementary Figure 2: Illustration of Output and GDP Module

The domestic final demand, here represented by  $FD_i$  ( $f_i^{dom}$  in the equations above), and its components are shown on the top-left part of the figure. Parameters  $\eta$  indicate the energy efficiency in the two energy-supplying industries which modify their technical coefficients in matrix  $A$ . Variable  $M$  designates the sum of imports from households consumption  $C$ , investment  $I$  and government  $G$  that affect the GDP. The pink box ( $XR$ ) represents the export reduction assumed under the degrowth scenario, explained in the following section and summarized in the Supplementary Results.

## International trade

The two graphs in the bottom of Supplementary Figure 7 (see Section 1.8) show the time series of the shares of households imports with respect to their consumption by industry. There are no clear trends, the observed import shares are quite stable over time. This observation leads us to model *imports* as a constant share of output for industries and of final consumption for households. Hence, import variations depend on the level of national income and its composition since there are different import shares for consumption, investment, public expenditure and intermediate goods.

*Exports*, on the other hand, are negatively affected by an increase in domestic industry prices – i.e. price inflation

should reduce an industry's exports – and they are also driven by an exogenous growth rate (1.6% per year).<sup>16</sup> Thus, productivity gains, due to unit labour and intermediate cost reductions, have positive effects on the current account of the trade balance. Moreover, the simulations that include consumption reduction – Degrowth scenario in the main text – also consider an export reduction to avoid an expansionary effect on exports due to falling prices that would, ultimately, offset the contraction of domestic demand and greenhouse gas emissions from consumption degrowth. We define exports ( $\chi_t^i$ ) of industry  $i$  as:

$$\chi_{i,t} = (1 + g_\chi)\chi_{t-1} \cdot (1 - \gamma_\chi \dot{p}_{i,t}), \quad (9)$$

where  $g_\chi = 0.016$  is the exogenous exports growth rate,  $\gamma_\chi = 1$  is a constant elasticity of exports to domestic price variations, and  $\dot{p}_{i,t}$  is the variation of industry's  $i$  prices in  $t$  with respect to the previous period.

The complexity of international trade and the absence of international capital flows in our model make it particularly challenging to model exchange rates. Even though we could consider the purchase power parity (PPP) – determined by domestic and foreign price levels – or uncovered interest parity (UIP) – given by the differential of domestic and foreign interest rates – as rules for exchange rate determination they would require *ad-hoc* assumptions on the variations of foreign prices or interest rates. Moreover, there is no conclusive empirical evidence in favor of these two hypotheses for exchange rate determination (Engel, 2000; Flood and Rose, 2002). Thus, any reasonable attempt would require modelling prices and demand of the trading partners, as well as international capital flows and currency, carry trade activity which seems to be an important determinant of contemporary exchange rate movements (Spronk et al., 2013). For these reasons we opt to define a simple rule that connects exports to variations in domestic prices to reflect the competitiveness of national with respect to foreign industries.

## 1.4 Households Income

This Section describes in greater detail the multiple sources of income from labour and government transfers for individuals in different occupational status: employed, unemployed, retired and inactive.

### Employed workers

The first component of employed workers income is the sum of their gross wage bill, paid by each industry to workers of the three skill levels ( $GWB_{i,j}$ ), that is given by the hourly wage ( $w_{j,i}$ ) multiplied by the average annual hours ( $h_i$ ) and the number of employed workers in a certain skill  $L_{i,j}$ .<sup>17</sup> Namely,

$$GWB_j = \sum_i w_{j,i} \cdot h_i \cdot L_{i,j} \quad (10)$$

$$GWB = \sum_j GWB_j. \quad (11)$$

Labour income is taxed in two main components, a flat tax ( $t^A$ ) and a progressive one ( $t^B$ ). The type  $A$  tax combines the *contribution sociale généralisée* (CSG) and the *contribution au remboursement de la dette sociale* (CRDS) into a single 9.7% flat tax (specific to employees) levied on 98.25% (tax base factor independent of employment status) of gross pay, hence  $t^{A,E} = 0.097 \cdot 0.9825 = 0.0953$ .<sup>18</sup> Thus, tax  $A$  for employed workers in skill  $j$  is:

$$T_j^{A,E} = t^{A,E} \cdot \sum_i w_{j,i} h_i L_{i,j}. \quad (12)$$

<sup>16</sup>Note that this represents a parsimonious assumption with respect to the actual trend of French exports that grew of  $\sim 2.2\%$  per year from 2000 to 2014 (<https://data.worldbank.org/indicator/NE.EXP.GNFS.KD?locations=FR>).

<sup>17</sup>See subsection 1.7 for the definition of wages in the model.

<sup>18</sup>For the CSG, the 9.2% rate of 2018 is used instead of the 7.5% rate of 2014 (Service-public.fr, 2018).

Type *B* tax is progressive and varies according to the schedule in Supplementary Table 4. Income and their respective marginal tax rates are split into five brackets (in the range  $[\underline{b}_f, \bar{b}_f[$  for  $f = \{1, \dots, 5\}$ ).

**Supplementary Table 4: Tax schedule for taxable annual income**

France 2014	Fraction of taxable income in € $(\underline{b}_f \vdash \bar{b}_f)$	Rate % $(\theta_f^B)$
Bracket 1	0 $\vdash$ 9,690	0
Bracket 2	9,690 $\vdash$ 26,764	14
Bracket 3	26,764 $\vdash$ 71,754	30
Bracket 4	71,754 $\vdash$ 151,956	41
Bracket 5	> 151,956	45

Source: "Taxing wages", OECD (2015, p. 264).

Compulsory social security contributions by employees (national accounts indicator D613) are approximated to 14% of gross wages. Work-related expenses are calculated using the standard allowance of 10% of gross earnings (OECD, 2015, p. 262). Hence, the taxable income for type *B* tax is  $w_{i,j}^B = 0.692 \cdot w_{i,j} = (1 - 0.068 - 0.14 - 0.1)w_{i,j}$ . The tax rate per employee is computed as:

$$t_{i,j}^B = \sum_f t_f^B \cdot \min[(\bar{b}_f - \underline{b}_f), \max((w_{i,j}^B - \underline{b}_f), 0)] + t_5^B \cdot \max[(w_{i,j}^B - \underline{b}_5), 0] \quad (13)$$

For each bracket, the equation first checks whether the taxable income is higher than the floor of the bracket. After that, the equation checks whether the taxable income is higher than the bracket ceiling. Total type *B* taxes of employed workers in skill-group *j* are:

$$T_j^B = \sum_i t_{i,j}^B \cdot L_{i,j} \quad (14)$$

The net wage bill by skill (*NWB<sub>j</sub>*) is:

$$NWB_j = GWB_j - (T_j^A + T_j^B + D613_j) \quad (15)$$

where  $D613_j = 0.14 \cdot GWB_j$  is the aggregate social contributions of workers in skill-group *j*. In the baseline scenario, type *B* tax bracket floors change in 1:1 proportion to the economy-wide average yearly wage ( $\bar{w}_t h$ ), so that:

$$\frac{\Delta b_f(t)}{b_f(t-1)} = \frac{\bar{w}_t \cdot h}{\bar{w}_{t-1} \cdot h} - 1 \quad \text{for } f = \{2, 3, 4, 5\} \quad (16)$$

then  $b_{f,t} = b_{f,t-1} + \Delta b_{f,t} = b_{f,t-1} \frac{\bar{w}_t \cdot h}{\bar{w}_{t-1} \cdot h}$ .

## Unemployment benefits

The nominal gross *unemployment* benefit for skill *j* (*GUB<sub>j</sub>*) is a constant fraction ( $\omega$ ) of skill-specific average wages. Due to the lack of data, we do not have the exact number of unemployed benefit recipients.<sup>19</sup> Therefore, we apply a

<sup>19</sup>According to the OECD Social Benefit Recipients Database (SOCR), 2,254,202 persons received Unemployment Insurance and 434,903 persons received Unemployment Assistance in 2014, all from public institutions. The database refers to Unemployment Insurance as "Jobseeker's benefit" and to Unemployment Assistance as "Specific solidarity benefit". The insurance program name is "ARE (Aide au retour à l'emploi)", and the assistance one is called "ASS (Aide

coverage ratio ( $\phi \simeq 0.8$ ) to the unemployed population of skill  $j$  ( $L_{j,t}^U$ ) multiplied by the average annual labour income of employed workers in the same skills level ( $\frac{GWB_{j,t}}{L_{j,t}}$ ) to obtain the gross unemployment benefits of unemployed worker in skill-group  $j$  as:

$$GUB_j = \omega \cdot \phi \cdot \frac{GWB_{j,t}}{L_{j,t}} \cdot L_{j,t}^U \quad (17)$$

$$GUB = \sum_j GUB_{j,t}, \quad (18)$$

where  $GUB$  is the total gross benefits for unemployment and  $\omega = 0.57$  is the unemployment benefit-to-wage ratio. According to Eurostat's COFOG database, the general government sector incurred in € 42,016 million unemployment-related expenditures in 2014, of which € 36,301 million were cash benefits (national accounts indicator D62). We assume that all recipients of unemployment benefits are completely unemployed.<sup>20</sup> The ratio of unemployment benefits to wages is based on the OECD report "Tax-Benefit".<sup>21</sup>

The type  $A$  tax of 6.7% is levied on 98.25% of gross unemployment benefits (Service-public.fr, 2018), hence  $t^{A,U} = 0.068 \cdot 0.9825 = 0.0658$ . Total type  $A$  taxes of unemployed workers in skill-group  $j$  are then:

$$T_j^{A,U} = t_{A,U} \cdot GUB_j \quad (19)$$

In type  $B$  taxes, allowances are made for 3.8% of CSG,<sup>22</sup> and for social contributions. Based on the OECD report "Tax-Benefit", unemployed individuals are assumed to pay 5.3% of gross unemployment benefits in social contributions.<sup>23</sup> Hence, type  $B$  taxable unemployment benefit per person is  $GUB_{j,U}^B = 0.909 \cdot GUB_j = (1 - 0.038 - 0.053)GUB_j$ . Type  $B$  tax per covered unemployed person is determined as for employees (but without the need to sum over industries) as:

$$t_j^{B,U} = \sum_f t_f^B \cdot \min[(\bar{b}_f - \underline{b}_f), \max((GUB_j^B - \underline{b}_f), 0)] + t_5^B \cdot \max[(GUB_j^B - \underline{b}_5), 0], \quad (20)$$

The total amount for skill-group  $j$  is:

$$T_j^{B,U} = cr_U \cdot t_j^{B,U} \cdot L_{j,U}, \quad (21)$$

while the net unemployment benefits in skill-group  $j$  are:

$$NUB_{j,t} = GUB_{j,t} - T_{j,t}^{A,U} - T_{j,t}^{B,U} - D613_{j,t}^U \quad (22)$$

where  $D613_{j,t}^U = 0.053 \cdot GUB_j$  is the aggregate social contributions of unemployed individuals of skill-group  $j$ .

---

Spé cifique de solidarité)" (SOCR\_Metadata\_FRA.pdf). There may be an overlap between programs, and many recipients are partially employed. See OECD SOCR files SOCR\_UBPpseudoCoverageRates.xlsx; BenRecipients\_FRA\_2016.xlsx.

<sup>20</sup>In reality, "in France, in the second quarter 2015, about 700 thousand beneficiaries of the unemployment insurance were in work" (OECD SOCR Database, <http://www.oecd.org/social/recipients.htm>).

<sup>21</sup>Available at OECD.Stat under Benefits, Taxes and Wages - Net Incomes, [https://stats.oecd.org/Index.aspx?DataSetCode=\\$FIXINCLSA](https://stats.oecd.org/Index.aspx?DataSetCode=$FIXINCLSA).

<sup>22</sup>"CSG et CRDS sur les revenus d'activité et de remplacement" (<https://www.service-public.fr/particuliers/vosdroits/F2971>).

<sup>23</sup>This percentage (5.26%) is constant from 70% to 200% of average wages and somewhat lower below the 70%.

## Pensions

The third group is composed by retired individuals: the population aged 65 or more ( $N^P$ ) whose income depends on public pensions and individual benefits that are proportional to average annual income of each skill category. Let  $pw$  be the pension-to-wage ratio,<sup>24</sup> assumed to be a fixed parameter calculated as:

$$pw = \frac{D62^{OS}}{\sum_j(\bar{w}_j h \cdot N_j^P)} = 0.799 \quad (23)$$

where  $\bar{w}_j h$  is the skill-specific average annual gross wage,  $N_j^P$  is the population aged 65 or over in skill  $j$  and  $D62^{OS}$  is the total of cash transfers in the “Old age and Survivors” benefits categories in Eurostat’s COFOG database. These transfers are assumed to vary in proportion to the wages of employed workers of the same skill group and to number of individuals aged 65 or above in each group.<sup>25</sup> The resulting pension-to-wage ratio ( $pw$ ) in 2014 was 79.9% (71.0% excluding survivors’ benefits). Hence, the gross pension benefit ( $GPB_j$ ), by skill is:

$$GPB_j = pw \cdot \frac{GWB_j}{L_j} \cdot N_j^P \quad (24)$$

The type  $A$  tax rate is of 8.8% over 100% of gross old-age pensions (Service-public.fr, 2018), hence  $t^{A,P} = 0.088$ . Total type  $A$  taxes of the 65+ cohort in stratum  $j$  are:

$$T_j^{A,P} = t^{A,P} \cdot GPB_j \quad (25)$$

For type  $B$  taxes, allowances are made for 5.9% of  $CSG$ , and for social contributions. Pensioners pay 7.3% of gross income in social contributions so that type  $B$  taxable income per pensioner is  $GPB_j^B = 0.868 \cdot GPB_j = (1 - 0.073 - 0.059)GPB_j$ . Type  $B$  tax per retired person is determined as for unemployed individuals:

$$t_j^{B,P} = \sum_f t_f^B \cdot \min[(\bar{b}_f - \underline{b}_f), \max((GPB_j^B - \underline{b}_f), 0)] + t_5^B \cdot \max[(GPB_j^B - \underline{b}_5), 0] \quad (26)$$

Thus, the total type  $B$  taxes from retirees in skill-group  $j$  are:

$$T_j^{B,P} = t_j^{B,P} \cdot N_{j,P}, \quad (27)$$

while the net pension benefits ( $NPB_j$ ) in skill-group  $j$  are given by:

$$NPB_j = GPB_j - T_j^{A,P} - T_j^{B,P} - D613_j^P \quad (28)$$

where  $D613_j^P = 0.073 \cdot GPB_j$  is the aggregate social contributions of pensioners in skill-group  $j$ .

## Other social protection transfers

The *Eurogreen* model includes *other social protection transfers* to provide a realistic picture of the French welfare system. Supplementary Table 5 presents a non-comprehensive breakdown of the largest components in social protection expen-

<sup>24</sup>In France, the minimum legal pension age is 62 years, and the full rate pension age is 67 years (European Commission directorate-general for economic and financial affairs, 2015a, p. 42) and (OECD, 2013, p. 249). According to the OECD Pensions at a Glance database, the employment rates of older workers in 2014 were: 68.3% for ages 55-59, 25.1% for ages 60-64, and 5.6% for ages 65-69. The effective labourmarket exit age was 59.4 years for men and 59.8 years for women. However, due to the lack of data on activity or retirement before and after the age of 62, we proceed as if the retirement age were 65.

<sup>25</sup>Actually, according to (European Commission directorate-general for economic and financial affairs, 2015b, p. 326), the total number of pensioners in France in 2013 was 18.390 millions, of which 6.134 millions (33.4%) aged below 65 and 12.256 millions aged 65 or above.

diture of the public sector (S13), focusing on social benefits other than social transfers in kind (D62) and social transfers in kind (D632).

**Supplementary Table 5: General French government expenditure on social protection (2014)**

Code	COFOG99	Total million €	of which D62	of which D632
GF10	Social protection	526731	419965	34393
GF1001	Sickness and disability	59067	34608	3464
GF1002	Old age	291652	266602	5926
GF1003	Survivors	34054	33645	0
GF1004	Family and children	53850	31217	6845
GF1005	Unemployment	42016	36301	0
GF1006	Housing	20090	1099	16738
GF1007	Social exclusion n.e.c.	21619	16070	1420
GF1008	R&D Social protection	0	0	0
GF1009	Social protection n.e.c.	4382	422	0

Source: Eurostat COFOG.

Total = Total general government expenditure;

D62 = Social benefits other than social transfers in kind;

D632 = Social transfers in kind - purchased market production;

n. e. c. = not elsewhere classified.

The modelling of social protection expenditures concentrates in cash transfers, ignoring in-kind provision of goods and services, which instead are aggregated into the final consumption expenditure of general government, as in the national accounts. Aggregate cash transfers (D62) for social protection purposes (in million €) are given by:  $D62^{SP} = \sum_{j \in \{H,L,M\}} D62_j^{SP}$ , which, for each socio-economic stratum, breaks down into five different types of transfers:

$$D62_j^{SP} = D62_j^{SD} + D62_j^{OS} + D62_j^{FC} + D62_j^U + D62_j^{RSA} \quad (29)$$

where *SD* indicates sickness and disability benefits, *OS* are old age and survivors pensions, *FC* family and children benefits, *U* unemployment benefits, and *RSA* (*Revenu de Solidarité Active*) social exclusion n.e.c. *RSA* is paid only to low-skill households. Given the relatively small size of cash benefits in the categories housing and social protection, they are omitted from the model. For simplicity, we assume that all other social transfers other than unemployment benefits and pensions are non-taxable and that no social contributions are levied on them.

The € 34,608 million spent on *SD* under D62 in 2014 (see Supplementary Table 5) are assumed to be paid in equal amounts to all working-age adults (18-64), independent of skill level, as the number of actual recipients is not modelled. For a population of 39,439,670, this corresponds to an annual benefit of € 877.48 per capita. Following (Browne and Immervoll, 2017, p. 5), we assume that disability benefits are reduced by the amount of the *BI* for actual recipients whenever this policy is introduced. To calculate this reduction, we use the residual of the savings on non-pension benefits for a *BI* set at the guaranteed minimum income level of € 465 per month in 2015, net of taxes (Browne and Immervoll, 2017, p. 12) obtained after subtracting D62 transfers for Unemployment and Social exclusion n.e.c. – which the *BI* replaces in full – from total savings on non-pension benefits calculated for France in 2015 by (Browne and Immervoll, 2017, p. 11), hence the *reduction of disability benefits* is of  $69,400 - 36,301 - 16,070 = 17,029$  million €.

We divide total cash benefits for Family and Children ( $D62^{FC}$ ) by the number of children in 2014 which gives a quarterly benefit of € 2,111.6 per under-age person in 2014. Benefits of stratum *j* are given by:

$$FC_{j,t} = FC_{j,t}^{PC} \cdot \bar{g}_{CPI,t} \cdot N_{j,F}(t) \quad (30)$$

where  $FC_{j,t}^{PC}$  is the amount per child and  $N_j^F$  is the number of children in skill  $j$ . The associated government expenditures are then:

$$D62^{FC} = \sum_j FC_j \quad (31)$$

According to metadata from Eurostat's COFOG database, the category *Social exclusion n.e.c.* mainly includes the social assistance program (*RSA*). In December 2014, about 2.89 millions of adults received some form of *RSA*. Although part of the *RSA* program is in-work income support, we assume that *RSA* is only paid to the unemployed or inactive low-skill individuals. Dividing total cash transfers (*D62*) in this category by the number of *RSA* recipients gives an average monthly payment of € 464 per recipient, close to the various *RSA* modalities reported by Family Benefits Fund (*CAF*), as well as the guaranteed minimum income of € 465 in 2015 considered by [Browne and Immervoll \(2017, p. 12\)](#). The overall yearly amount for *RSA* is of € 5,568. We make the preliminary assumption that the *RSA* is paid out to a fixed percentage  $cr_{RSA} = 0.451$  of unemployed and inactive low-skilled working-age persons (aged between 15-64), calculated as the ratio of *RSA* recipients to low-skill individuals in 2014. The introduction of the *BI* policy abolishes the *RSA*. The *JG* program, if implemented without the *BI*, abolishes the *RSA* for the unemployed, but not for the inactive.

We can thus define disposable income, per skill, as the sum of net labour income, net unemployment and pension benefits and the three remaining social transfers described in this section: family and children (*FCA*), sickness and disability (*SDB*) and the *RSA*. In addition to these, middle- and high-skill households also receive a net financial income (*NFI<sub>j</sub>*) from bonds and equity that are described in detail in the next Section.

$$YD_j = NWB_j + NUB_j + NPB_j + D62_j^{FC} + D62_j^{RSA} + D62_j^{SD} + NFI_j \quad (32)$$

## Capitalists

Finally, capitalists (*cap*) receive a gross disposable income from ownership of equity and bonds. That income is from interest payments, price variations in both bonds and equities and dividends paid out of profits. A detailed description of the financial income received by capitalists, middle- and high-skill households is presented in the following Section. Capitalists disposable income is simply given by:

$$YD_{cap} = NFI_{cap} \quad (33)$$

The different income sources of households by skill and occupational status is summarized in Supplementary Table 6, while the main income and tax variables that determine disposable income (*YD*) are illustrated in Supplementary Figure 3.

Supplementary Table 6: List of income sources for workers and capitalists

Category	Employed	Unemployed	Inactive	Retired
Low skill	Wages	Unempl. benefits <i>RSA</i>	<i>FCB</i> <i>RSA</i> <i>SDB</i>	Pensions
	Mixed Income			
Middle skill	Wages	Unempl. benefits	<i>FCB</i> <i>SDB</i>	Pensions
	Financial Income: Public Bonds Mixed Income			
High skill	Wages	Unempl. benefits	<i>FCB</i> <i>SDB</i>	Pensions
	Financial Income: Public Bonds, Equity, Dividends Mixed Income			
Capitalists	Financial Income: Public Bonds, Equity, Dividends Mixed Income			

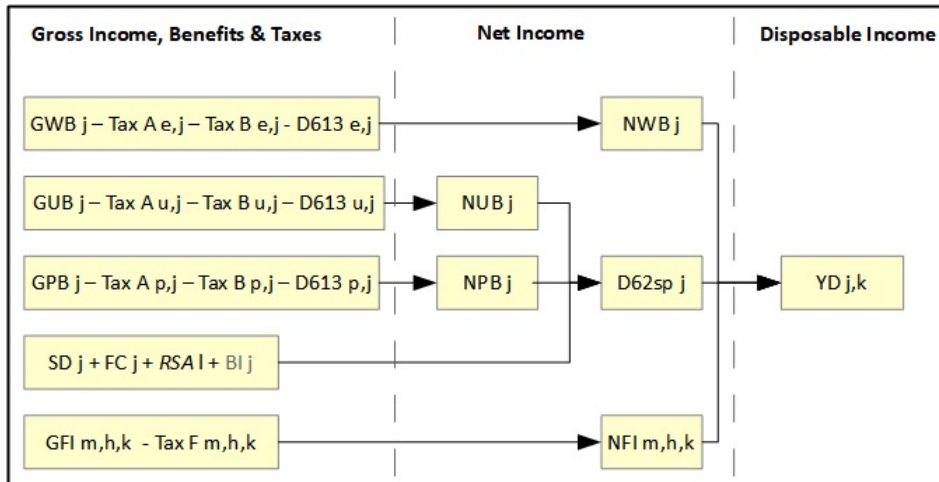

Supplementary Figure 3: Illustration of Households' Disposable Income

Subscripts  $j = [L, M, H]$  and  $k$  represent households of the three skill levels and capitalists, respectively. The subscripts  $e$ ,  $u$  and  $p$  – presented as superscripts in the text equations – indicate employed, unemployed and retired individuals. The basic income benefits ( $BI_j$ ) are highlighted in gray because they are not always presented in the simulations.



## 1.5 Wealth distribution, financial income, and portfolio choice

### Wealth distribution

The distribution of wealth among socio-economic groups is based on data for France taken from the World Wealth and Income Database (WID) (see <https://wid.world/>) that accounts for the resident population aged 20 years or over, organised in percentiles.<sup>26</sup> The skill shares of the 20+ population reported in Supplementary Table 1 can be expressed cumulatively, so that the low-skilled group represents the lower 0-30.7% interval, the middle-skilled the 30.7-71.6% interval, and the high-skilled the 71.6-100% interval. This corresponds quite well to the decile structure of the WID data (with finer divisions at the top). Thus, we map the low-skilled set onto the bottom 0-30 percentile, the medium-skilled onto the 30-70 percentile, and the high-skilled onto the 70-99.9 percentile. We reserve the 99.9-100 percentile for the fourth socio-economic category of capitalists, who are assumed not to earn any wages or other forms of non-financial income. Representing 0.1% of the 20+ population, the number of capitalists or rentiers is of 65,940 individuals as of the end of 2014). The assumption that the difference in the educational attainment of the population coincides with the difference in wealth (and income) is, of course, merely an approximation to reality. An additional assumption is implied by the nature of the WID data: the unit of reference is the individual, not the household.<sup>27</sup>

Financial wealth represented 43.9% of households net wealth in 2014. The remaining 56.1% consisted mainly of housing, but also non-financial business assets.<sup>28</sup> The WID database includes four classes of financial assets: deposits, bonds, equities, and life insurance and pension funds (LIPF). However, we exclude LIPF from the assets because the historical evolution of its portfolio weight appears to be based more on political-institutional developments than on relative returns. Instead, the share of financial wealth held in this form is fixed at its 2014 end-of-year value. This simplification finds some support in the leveling out of this share in recent times.

The initial distribution of wealth, whose total is of 2.816 trillion euros in 2014, among households of the three skills and capitalists is: 2.2% low-skill, 11.3% middle-skill, 70.4% high-skill and the remainder 16.1% capitalists. The relatively large amount of wealth held by high-skill workers with respect to capitalists is explained by the fact that the former constitute the vast majority of the higher income earners, including the majority of the top 1% in income distribution. Still the per capita income of capitalists, top 0.1%, is far larger than that of high-skill workers.

**Supplementary Table 7: Distribution of financial assets across socio-economic groups (2014)**

France (%)	Deposits	Bonds	Equities	Tot
Low-skill	100.00	0.00	0.00	100
Medium-skill	68.79	31.21	0.00	100
High-skill	18.03	76.57	05.40	100
Capitalists	01.77	50.99	47.24	100

Source: Own calculations based on Garbinti et al. (2017).

<sup>26</sup>Although the minimum age considered is 20 (Garbinti et al., 2017), the outcome given for the total resident adult population in 2014 (51,721,509) is closer to Eurostat data for the resident 18+ population (51,673,737) than the 20+ population (50,087,875) as of January, 1<sup>st</sup> 2015. The Eurostat database include all five overseas departments, but possibly not the communities nor territories ([http://ec.europa.eu/eurostat/cache/metadata/en/demo\\$\\_pop\\$\\_\\$esms.htm](http://ec.europa.eu/eurostat/cache/metadata/en/demo$_pop$_$esms.htm)).

<sup>27</sup>It is usually not possible to divide the wealth of married couples on the basis of unequal individual property rights, in which case the wealth is simply divided by two (Garbinti et al., 2017, p.17). Thus, the Eurogreen model implicitly assumes that married couples belong to the same skill (Garbinti et al., 2017, Table B1). Average adult net wealth in France in 2014 was 197,379 €. This represents financial wealth plus non-financial wealth including housing net of debt. Multiplied by the total adult population (51,721,509), the total wealth of adults in 2014 was about €10.2 trillion.

<sup>28</sup>The wealth composition figures reported in WID satisfy the formula Non-Financial Assets + Financial Assets - Debt = 100%. Using figures of 2014: 69.2% + 43.9% - 13.1% = 100%. Debt is subtracted from housing assets to obtain net wealth.

Supplementary Table 7 shows the distribution of financial asset within the wealth of each skill group and capitalists. Low-skill individuals hold only bank deposits so that they have no portfolio choice neither earn financial income. Deposits are assumed not to pay any interest in the model. Middle-skill households have about 70% of their wealth in deposits and the rest of it as bonds. The composition of their portfolio is assumed to be fixed since they receive a financial income from only one of their assets: bonds. As seen in the next subsection the actual portfolio choice model applies only to high-skill individuals and capitalists who jointly held about 86% of net national financial wealth in 2014.

## Portfolio choice model

We model portfolio choice following [Godley and Lavoie \(2016\)](#), who developed the approach first presented by [Brainard and Tobin \(1968\)](#) and [Tobin \(1969\)](#). This module determines how the composition of the wealth of each socio-economic group responds to variations in the rates of return on different asset classes.

We apply a vertical adding-up constraint, according to which “the vertical sum of the coefficients in the rates of return matrix must be zero”, so that “the sum over all assets of responses to a change in any of the rates of return is zero” ([Godley and Lavoie, 2016](#), p. 144).

Furthermore, we omit the effect of the disposable income to wealth ratio on the demand for deposits, which is usually included in portfolio models of this kind. This omission is due to the lack of data on disposable income by wealth percentile. [Garbinti et al. \(2017\)](#) present this data for the 0.1 percentile, but not for the 70-99.9 percentiles. The initial rates of return are annual average rates from the WID database.

- $rrbn_{cg}^*$ : rate of return on bonds, including capital gains, net of taxes;
- $rren_{cg}^*$ : rate of return on equities, including capital gains, net of taxes;
- $rrdn^*$ : rate of return on deposits, set to 0.

The three portfolio equations of each socio-economic group can be written in matrix form as:

$$\begin{pmatrix} \Delta \frac{B}{V} \\ \Delta \frac{Eq}{V} \\ \Delta \frac{D}{V} \end{pmatrix} = \begin{pmatrix} a_{11} & a_{12} & a_{13} \\ a_{21} & a_{22} & a_{23} \\ a_{31} & a_{32} & a_{33} \end{pmatrix} \cdot \begin{pmatrix} rrbn_{cg}^* \\ rren_{cg}^* \\ rrdn^* \end{pmatrix} \quad (34)$$

Where  $B$  is the stock of bonds,  $Eq$  the stock of equities,  $D$  the stock of deposits and  $V$  the total financial wealth. On the right-hand side, there is a matrix of coefficients, followed by a vector of rates of return. In principle, the own-rates on the main diagonal of the coefficients matrix should be positive, and the others should be negative. The vertical adding-up constraint means that each column of the coefficients matrix should sum to zero. The two systems of equations below represent the portfolio choice equations for high-skill workers and capitalists. In both cases the share of wealth allocated to deposits is obtained as a residual. It is further assumed that the desired portfolios are achieved by the end of each period ([Godley and Lavoie, 2016](#), p. 143). The portfolio shares are given by:

$$\frac{X_{s,t}}{V_{s,t}} = \frac{X_{s,t-1}}{V_{s,t-1}} + \Delta \frac{X_{s,t}}{V_{s,t}} \quad \forall X = \{B, Eq, D\}, s = \{H, cap\} \quad (35)$$

In what follows the parameter values for the high-skill group ( $H$ ):<sup>29</sup>

$$\begin{pmatrix} \Delta \frac{B_H}{V_H} \\ \Delta \frac{Eq_H}{V_H} \\ \Delta \frac{D_H}{V_H} \end{pmatrix} = \begin{pmatrix} 0.10 & -0.09 & 0 \\ -0.16 & 0.12 & 0 \\ 0.06 & -0.03 & 0 \end{pmatrix} \cdot \begin{pmatrix} rrbn_{cg}^* \\ rren_{cg}^* \\ rrdn^* \end{pmatrix} \quad (36)$$

<sup>29</sup>All the procedure and the statistical analysis behind these estimations are available on request.

and for capitalists (*cap*)

$$\begin{pmatrix} \Delta \frac{B_{kp}}{V_{kp}} \\ \Delta \frac{E_{kp}}{V_{kp}} \\ \Delta \frac{D_{kp}}{V_{kp}} \end{pmatrix} = \begin{pmatrix} 0.38 & -0.12 & 0 \\ -0.37 & 0.12 & 0 \\ -0.01 & 0 & 0 \end{pmatrix} \cdot \begin{pmatrix} rrbn_{cg}^* \\ rren_{cg}^* \\ rrdn^* \end{pmatrix} \quad (37)$$

The last equations imply that capitalists are more sensitive than high-skill workers to the rate of return on bonds for their choice between bonds and equities, although their sensitivity to the rate of return on equities is rather similar.<sup>30</sup>

## Financial income

As mentioned at the end of subsection 1.4 the pre-tax gross financial income of households is the sum of the revenues from their asset holdings plus gains from price changes of those assets. For higher-income groups (*M*, *H*, and *cap*) it is the sum of the revenues from bonds and equities, plus nominal capital gains on the same assets. Gross financial income ( $GFI_j$ ) is given by:<sup>31</sup>

$$GFI_{j,t} = i_t^B \cdot B_{t-1}^j + \sum_i Div_{j,i,t} + G_{j,t-1}^b + G_{j,t}^{Eq} \quad (38)$$

where  $i_t^B$  is the nominal interest rate on government bonds,  $B$  is the stock of bonds, and  $Div_{i,t}^j$  are the dividend payments by each industry  $i$ .  $G^B$  and  $G^{Eq}$  are the nominal capital gains on bonds and equities, respectively, calculated as the current change in their prices multiplied by the stock at the end of the previous period:

$$G_{j,t}^b = \Delta p_B \cdot B_{t-1}^j \quad (39)$$

$$G_{j,t}^{Eq} = \Delta p_E \cdot Eq_{t-1}^j \quad (40)$$

The *Eurogreen* model applies a 30% flat tax ( $t^F = 0.30$ ) on financial income introduced in 2018. More precisely, the levy consists of a 12.8% income tax and a 17.2% charge for social contributions, both incorporated into a single flat tax. Taxes on financial income paid by each skill-group  $j$  are:

$$T_{j,t}^F = t^F \cdot [i_t^B \cdot B_{t-1}^j + Div_{j,t} + \max(G_{j,t-1}^b, 0) + \max(G_{j,t}^{Eq}, 0)] \quad (41)$$

where the *max* functions ensure that negative capital gains do not result in negative taxes. Note that the rate of interest on deposits is assumed to be non-negative. Hence, net financial income ( $NFI_{j,t}$ ) is:

$$NFI_{j,t} = GFI_{j,t} - T_{j,t}^F \quad (42)$$

## Financial Sector

In addition to the normal operations of investment and production performed by all industries in the model, the financial sector holds the stock of deposits from households ( $D$ ) and of private loans from other industries ( $H$ ). Since deposits do not pay interest the financial sector simply holds the number of private wealth households of different skills and capitalists decide to retain as deposits according to portfolio choice described above. The dynamics of the stocks of loans and equity are determined by private investments and explained in Section 1.9.

<sup>30</sup>Note that we do not impose the less essential horizontal and symmetry constraints (Godley and Lavoie, 2016, p. 144-145).

<sup>31</sup>As mentioned in the beginning of this Section low-skill households earn no financial income and middle-skill ones receive only interest from bonds.

## Interest rates

The basic interest rate is determined by the Central Bank reaction function. Starting from the Euro overnight index average (*EONIA*) of 0.02% in 2014, the Central Bank increases this basic rate as a positive function of deviations of the consumer price index inflation rate from the yearly target of 2%. However, since the model simulates exclusively the French economy, we assume that the reaction function depends on national inflation only and not on the Euro area inflation rate as the European Central Bank actually does.

$$EONIA_t = EONIA_{t-1} + d^{BCE}(\Delta CPI_{t-1} - 0.02), \quad (43)$$

where  $d^{BCE} = 1.15$  is the Central Bank sensitivity to deviations from the target. The interest rate paid on private debt by industries is then set to move together with the basic rate.

$$i_t = \max[i_{t-1} + 0.201806(d^{BCE}(\Delta CPI_{t-1} - 0.02)) + 0.335394(d^{BCE}(\Delta CPI_{t-2} - 0.02))]. \quad (44)$$

A summary of the different financial assets, their creditors and debtors is presented in Supplementary Figure 4. Bond issuance by the government not presented in this section are described in subsection 1.11.

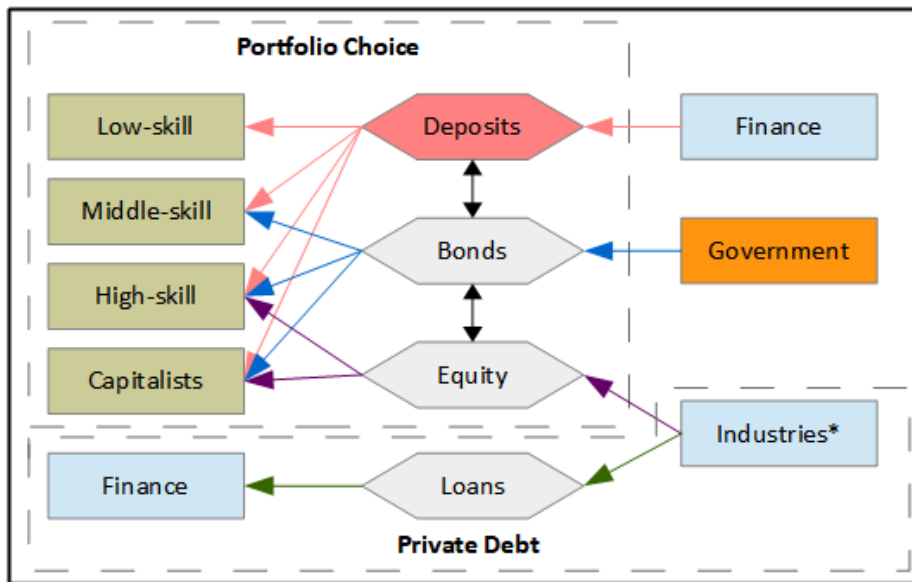

Supplementary Figure 4: Illustration of the Financial Assets Module

The direction of the arrows go from the agents/industries that issue the assets to those that own them. The black arrows across deposits, bonds, and equity indicate the portfolio choice model.

## 1.6 Innovation: labour productivity and energy efficiency

This Section extends the description presented in Methods about the modellization of technological progress in three steps: the emergence of innovation(s), firms choice and implementation of new technological mix. There is a growing literature studying the drivers of technological progress (Thoening and Verdier, 2003; Christensen et al., 2006; Nordhaus, 2010; Satchell, 2018). In particular, relative input prices - of energy and labour in our case - are crucial in shifting R&D investment decisions. This consideration leads us to assume an *endogenous* probability of the emergence of new technologies driven by changes in the relative cost of energy and labour. We assume that, in each period, the set of four technologies ( $\gamma$ ) consisting in combinations of labor productivity ( $\lambda$ ) and energy efficiency ( $\eta$ ), as reported in Supplementary Table 8.

**Supplementary Table 8: Set of new technologies**

<i>Technology</i>	$\lambda$	$\eta$
$\gamma_1$	$\lambda_{1,t} = \lambda_{t-1}$	$\eta_{1,t} = \eta_{t-1}$
$\gamma_2$	$\lambda_{2,t} > \lambda_{t-1}$	$\eta_{2,t} < \eta_{t-1}$
$\gamma_3$	$\lambda_{3,t} < \lambda_{t-1}$	$\eta_{3,t} > \eta_{t-1}$
$\gamma_4$	$\lambda_{4,t} > \lambda_{t-1}$	$\eta_{4,t} > \eta_{t-1}$

Columns  $\lambda$  and  $\eta$  present the direction of the variation in labour productivity and energy efficient, respectively, in each technology.

Note that  $\gamma_1$  ( $\Delta\lambda = \Delta\eta = 0$ ) corresponds to no innovation. Under  $\gamma_2$  ( $\gamma_3$ ), we have  $\Delta\lambda > 0$  ( $< 0$ ) and  $\Delta\eta < 0$  ( $> 0$ ). Finally, both labor productivity and energy efficiency increase simultaneously in  $\gamma_4$ .

Each technology has a probability of extraction of ( $P_n = p(\gamma_n)$ ) for all  $n = [1, 2, 3, 4]$ . For  $\gamma_1$ , the old technology, this probability is equal to one since it is always available, while  $P_2$  ( $P_3$ ) is an increasing (decreasing) function of ratio between the growth rates of labour and energy costs ( $\dot{\zeta}_{\eta,\lambda}$ ).<sup>32</sup> The probability of extraction of  $\gamma_4$  is fixed. The input-cost growth ratio for an industry  $i$  ( $\dot{\zeta}_{\eta,\lambda}^i$ ) is defined as:

$$\dot{\zeta}_{\eta,\lambda}^i = \frac{\frac{\Delta \sum_j \text{GWB}_{ij}(1+D613)}{\sum_j \text{GWB}_{ij,t-1}(1+D613)}}{\frac{\Delta \sum_k (Z_{k,i} + CT_i + ETS_i)}{\sum_k (Z_{k,i,t-1} + CT_{i,t-1} + ETS_{i,t-1})}} \quad (45)$$

where  $\sum_j \text{GWB}_{ij}(1+D613)$  is the gross wage bill paid by industry  $i$  augmented by the labour tax rate  $D613$ ,  $\sum_k (Z_{k,i} + CT_i + ETS_i)$  is the total energy cost given by the sum of the intermediate goods and services bought from the two energy-supplying industries  $Z_{k,i}$  with  $k = [ELG, C19]$ ,  $CT_i$  is the carbon tax and  $ETS_i$  the cost of emissions in the EU-ETS. A larger  $\dot{\zeta}_{\eta,\lambda}$  leads to a higher probability of labour-saving technology ( $\gamma_2$ ) because energy becomes relatively more cheaper than labor, so that industries incentive to reduce energy costs becomes relatively smaller. In contrast, when  $\dot{\zeta}_{\eta,\lambda}$  decreases, the probability of  $\gamma_3$  increases.

We can represent the probability of extracting each innovation as:

$$\begin{aligned} P_1 &= 1; \\ P_{2,t} &= P_{2,t-1} \cdot [1 + \theta \dot{\zeta}_{\eta,\lambda}]; \\ P_{3,t} &= P_{3,t-1} \cdot [1 - \theta \dot{\zeta}_{\eta,\lambda}]; \\ P_{4,t} &= P_4; \end{aligned}$$

where  $\theta$  is a positive parameter. Note that  $P_{4,t}$  is set as a constant and low value in order to make the probability of obtaining win-win innovations – that increase both labour productivity and energy efficiency – less likely than  $\gamma_2$  and  $\gamma_3$ . When available,  $\gamma_4$  is the cost-minimizing solution by definition. Thus, assuming that the  $P_z$  are independent and identically distributed, we can recover the probabilities of each technological combination as:

$$\begin{aligned} Y_1 &= (1 - P_2)(1 - P_3)(1 - P_4), \quad \text{only } \gamma_1 \text{ is available;} \\ Y_2 &= P_2 (1 - P_3)(1 - P_4), \quad \gamma_1 \text{ and } \gamma_2 \text{ are available;} \\ Y_3 &= P_3 (1 - P_2)(1 - P_4), \quad \gamma_1 \text{ and } \gamma_3 \text{ are available;} \\ Y_4 &= P_3 P_2 (1 - P_4), \quad \gamma_1, \gamma_2 \text{ and } \gamma_3 \text{ are available;} \end{aligned}$$

<sup>32</sup>The rate of growth of input cost ratio is, in theory, not constrained. However, the simulation do not generate values greater (lower) than 1 (-1). For this reason, we assumed that  $-1 < \dot{\zeta}_{\eta,\lambda} < 1$ .

$$Y_5 = P_4 [(1 - P_2)(1 - P_3) + P_2 (1 - P_3) + P_3 (1 - P_2)], \quad \gamma_1 \text{ and } \gamma_4 \text{ are available.}^{33}$$

In *step 2*, the available set of new technologies is known and firms choose the cost-minimizing one. In *step 3*, the selected new technology is installed only in new equipment, but not in the whole stock of capital. Hence, the average labour productivity depends on the mix of old and new technologies operating simultaneously, represented in equation (53). Similarly, for each industry, energy efficiency  $\eta_{i,t}$  is

$$\eta_{i,t} = \frac{\eta_{i,\alpha} I_{i,t} + \eta_{i,t-1} (1 - \delta_i) K_{i,t}}{I_{i,t} + (1 - \delta_i) K_{i,t}} \quad (46)$$

where  $\alpha$  stands for new available technology,  $I_{i,t}$  is the level of gross fixed capital formation,  $K_t$  the stock of capital and  $\delta_i$  is the capital depreciation rate (see Section 1.9). The resulting indicators ( $\lambda_{i,t}$  and  $\eta_{i,t}$ ) are applied to compute the overall energy and labour costs.

Supplementary Figure 5 provides a schematic representation of the three steps innovation process described above.

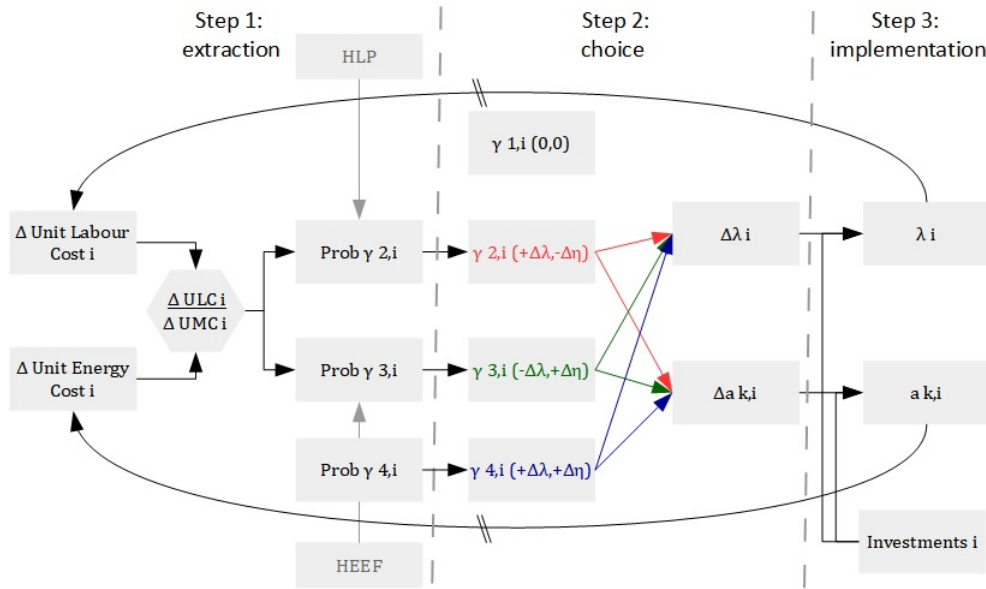

**Supplementary Figure 5: Three-steps innovation dynamic**

The arrows with two vertical bars (\\) indicate lagged effects. *HLP* and *HEEF* represent the *high labour productivity* and *high energy efficiency* respectively, described in the main text. The terms in parenthesis that follow each type of technology ( $\gamma_{n,i}$ ) indicate whether they increase or decrease labour productivity ( $\lambda$ ) and energy efficiency ( $\eta$ ).  $+\Delta\lambda_i$  represents greater labour productivity and  $+\Delta\eta$  represents more energy efficiency. Increases in energy efficiency then reduce the technical coefficients ( $\Delta a_{k,i}$ ) of the two energy-supplying industries  $k = [C19, ELG]$ .

## 1.7 Employment, wages and working time

Employment levels are determined by employers (industries) that hire workers and intermediate inputs to meet their demand. Labour supply and its composition depend both of population growth and labour market conditions, represented simply by unemployment rates.

<sup>33</sup>Any combination of  $\gamma_4$  ( $P_4$ ) and  $\gamma_2$  and/or  $\gamma_3$  is irrelevant because  $\gamma_4$  will be chosen whenever available.

## Labour Supply

The *labour force* ( $LF$ ) is composed by the working age population multiplied by the participation rate ( $\psi$ ) as illustrated in Supplementary Figure 1:

$$LF_t = (Pop_{II,t} + Pop_{III,t})\psi_t \quad (47)$$

The initial value of  $\psi$  is 0.711 and it fluctuates according to the difference between the overall unemployment rate  $u_t$  and its initial value of 10.29%:

$$\psi_t = \min(0.711 \cdot (1 - 3.5(u_{t-1} - 0.1029)), 1) \quad (48)$$

The initial composition of the labour force by skill ( $s_j^0$ ) is set to 18.57% of low-, 45.12% of middle- and 36.31% of high-skill workers. Although there is no education module, we model skill transitions with a simple procedure. We assume that the probability that a worker from group  $j$  changes her/his skill category depends on the difference in skill-specific unemployment rates ( $u_{j,t}$ ) multiplied by constant cross-group transition coefficient ( $\tau_{j \rightarrow i}$ ). We set higher coefficients for a downward shift (e.g., from middle to low-skill) than for upward skill mobility. That is, a  $\tau_{L \rightarrow M} < \tau_{M \rightarrow L}$  ensures that for differences in unemployment rates of the same absolute value, but with opposite signs, more middle-skill workers would be able to transit into low-skill than the other way around. This assumption is justified by the fact that individuals must invest time to acquire professional skills compatible with high-skill jobs. For instance in case of  $L$  we have:

$$s_{L \rightarrow M,t} = s_{L,t}(1 + \tau_{L \rightarrow M} \cdot \Delta u_{M,L}) \quad \text{if } \Delta u_{M,L} > 0, \quad (49)$$

$$s_{M \rightarrow L,t} = s_{M,t}(1 + \tau_{M \rightarrow L} \cdot \Delta u_{M,L}) \quad \text{if } \Delta u_{M,L} < 0, \quad (50)$$

where ( $\Delta u_{M,L} = u_{M,t-1} - u_{L,t-1}$ ). The values for the initial transition coefficients are:  $\tau_{L \rightarrow M} = 0.75$ ,  $\tau_{M \rightarrow L} = 1$ ,  $\tau_{M \rightarrow H} = 0.45$  and  $\tau_{H \rightarrow M} = 0.85$ . Supplementary Table 9 reports data on the labour Force Supply ( $LFS$ ) by level of educational attainment.

**Supplementary Table 9: Labour force by skill (2014)**

France	Low-skill	Middle-skill	High-skill	Total
Total pop, 15-64	10,880,767	17,922,695	12,192,037	40,995,499
Active population, age 15-64	5,418,622	13,173,181	10,558,304	29,150,107
Employed workers	4,481,201	11,763,650	9,882,573	26,127,424
Unemployed	937,422	1,409,530	675,731	3,022,683
Inactive population	5,462,145	4,749,514	1,633,733	11,845,392
Participation rate (%)	49.8	73.5	86.6	71.1
Unemployment rate (%)	17.3	10.7	06.4	10.4

Source: Own calculations based on Eurostat LFS (<https://ec.europa.eu/eurostat/web/microdata/european-union-labour-force-survey>). Notes: Resident population concept; non-respondents proportionally distributed across all skill categories.

The overall ( $u_t$ ) and skill specific ( $u_{j,t}$ ) unemployment rates are given by

$$u_t = \frac{LF_t - \sum_j \sum_i L_{i,j,t}^E}{LF_t} \quad (51)$$

$$u_{j,t} = \frac{LF_{j,t} - \sum_i L_{i,j,t}^E}{LF_{j,t}} \quad (52)$$

where  $LF_j$  is the labour force of skill  $j$  and  $L_{i,j}^E$  is the number of employed workers by skill ( $j$ ) and industry ( $i$ ). Moreover, we represent the inactive population (i.e., out of the labour force) as  $N_I$ , the number of working-age adults (age 18-64) as  $N_A$ , the number of children (age 0-17) as  $N_F$ , and the number of individuals aged 65 or above as  $N_P$ , who are all assumed to be pensioners (see Supplementary Table 9 for the actual distribution).

## Labour Productivity

The labour productivity by industry ( $\lambda_i$ ) is a weighted average of the labour productivity that corresponds to the latest technology adopted and that of the previous period, as mentioned in the end of section 1.6. That is, if industry  $i$  adopts a new technology  $\alpha$  with labour productivity  $\lambda_\alpha$  in period  $t$  its actual labour productivity will be given by

$$\lambda_{i,t} = \frac{\lambda_\alpha I_{i,t} + \lambda_{i,t-1}(1 - \delta_i)K_{i,t-1}}{I_{i,t} + (1 - \delta_i)K_{i,t-1}}. \quad (53)$$

The weights for the new and old labour productivities are the amount of the fixed capital that embodies these technologies: gross fixed capital formation ( $I_{i,t}$ ) and the stock of fixed capital after depreciation ( $(1 - \delta)K_{i,t}$ ), respectively.

## Employment

The number of employed workers by skill in an industry ( $L_{i,j}$ ) is a function of its labour productivity ( $\lambda_i$ ), yearly working hours ( $h_i$ ) and output  $y_i$ . The distribution of workers by skill is given by the initial fixed parameter matrix  $\sigma_{i,j}$  calculated from the EU-KLEMS project.<sup>34</sup> Moreover, following the contemporary labour economics literature, we model a job-polarization process that modifies the composition of skill demand by industry. Empirical studies over the last two decades (Goos et al., 2009) have unveiled a specific pattern in which technological progress and automation tend to substitute middle- while complementing both high- and low-skill work. Middle-skill occupations are more intensive in routine tasks that require codifiable and repetitive activities which are easier to automate. On the other hand, at least up until now, abstract and cognitive activities, typical of high-skill occupations, and also non-routine manual work that requires, for instance, hand-eye coordination also results to be less substitutable by machines. Thus, we assume that increases in labour productivity ( $g_{\lambda_i} = \frac{\lambda_{i,t} - \lambda_{i,t-1}}{\lambda_{i,t-1}}$ ) substitutes middle-, complements high- and, to a lesser extent, low-skill work through coefficients  $\rho_j = (1.5, -5, 3.5)$ . The employment in industry  $i$  of workers in skill  $j$  at period  $t$  is then represented by the following equation:

$$L_{i,j,t} = (1 + \rho_j \cdot g_{\lambda_i,t}) \cdot \frac{\sigma_{i,j} \cdot y_{i,t}}{\lambda_{i,t} \cdot h_i}. \quad (54)$$

Hours worked are defined by industry but do not differ by skill. Once again, they are based on EU KLEMS data from which we calculate a vector of the difference in yearly hours worked by industry ( $\hat{h}_i$ ) with respect to the economy average of yearly hours, given by the multiplication of average weekly hours ( $\bar{h}$ ) by 43 weeks, namely:

$$h_i = \hat{h}_i \cdot \bar{h} \cdot 43. \quad (55)$$

The simulated evolution of employment, by skill, in the baseline scenario of the model is presented for selected years in Supplementary Table 10. The polarization is visible in the decrease in the share of employed middle-skill workers with respect to the other two skill groups.

## Wages

Initial wages by skill and industry ( $w_{i,j}^0$ ) are calculated using EU-KLEMS data. Wage dynamics depend positively on the growth rates of industry employment ( $g_{L_{i,t}}$ ) and labour-productivity ( $g_{\lambda_{i,t}}$ ). The decision to render wages sensitive to the growth of employment in each industry, instead of unemployment rates, was taken to reflect a higher degree of stratification among occupations. Setting wages as a function of employment makes it responsive to industry-specific

<sup>34</sup>See [http://www.euklems.net/project\\_site.html](http://www.euklems.net/project_site.html).



**Supplementary Table 10: Employment by skill under the baseline scenario**

Skills	2014	2030	2050
<i>Low-skill</i>	17.11%	17.39%	18.02%
<i>Middle-skill</i>	44.88%	43.26%	41.82%
<i>High-skill</i>	38.01%	39.35%	40.16%

Note: these values are the averages over 500 simulations.

dynamics and couples the labour cost of an industry to its current output and profits. The alternative, to have wages in all industries as a function of general or skill-specific unemployment rates, would be equivalent to assume a high degree of substitutability between workers with the same skill in different industries.

$$w_{i,j,t} = w_{i,j}^0 (1 + \omega_{\lambda,j} g_{i,t}^{\lambda} + \omega_{L,j} g_{i,t}^L). \quad (56)$$

where  $\omega_{\lambda,j}$  and  $\omega_{L,j}$  are skills-specific constant parameters ( $j = \{L, M, H\}$ ). In both cases, high-skill wages are assumed to be more sensitive to increases in productivity and employment.

$$\omega_{\lambda,j} = [0.7, 0.7, 0.9], \quad (57)$$

$$\omega_{L,j} = [0.5, 0.5, 0.7]. \quad (58)$$

Supplementary Figure 6 summarizes the main variables of the labour module, except for labour supply which is presented in Supplementary Figure 1.

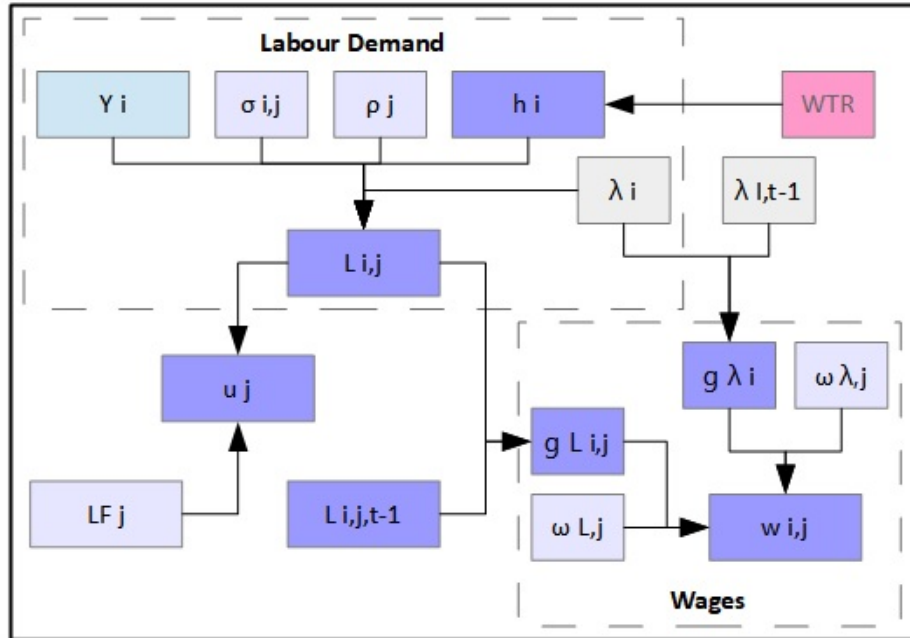

**Supplementary Figure 6: Illustration of the Labour Module**

The  $WTR$  variable in the pink box represents the working time reduction policy which directly impacts work-hours  $h_i$ .

## 1.8 Households Consumption

Households consumption is assumed as a fixed proportion of the disposable income and wealth which is distributed between goods and services supplied by the 10 industries (both domestic and foreign).

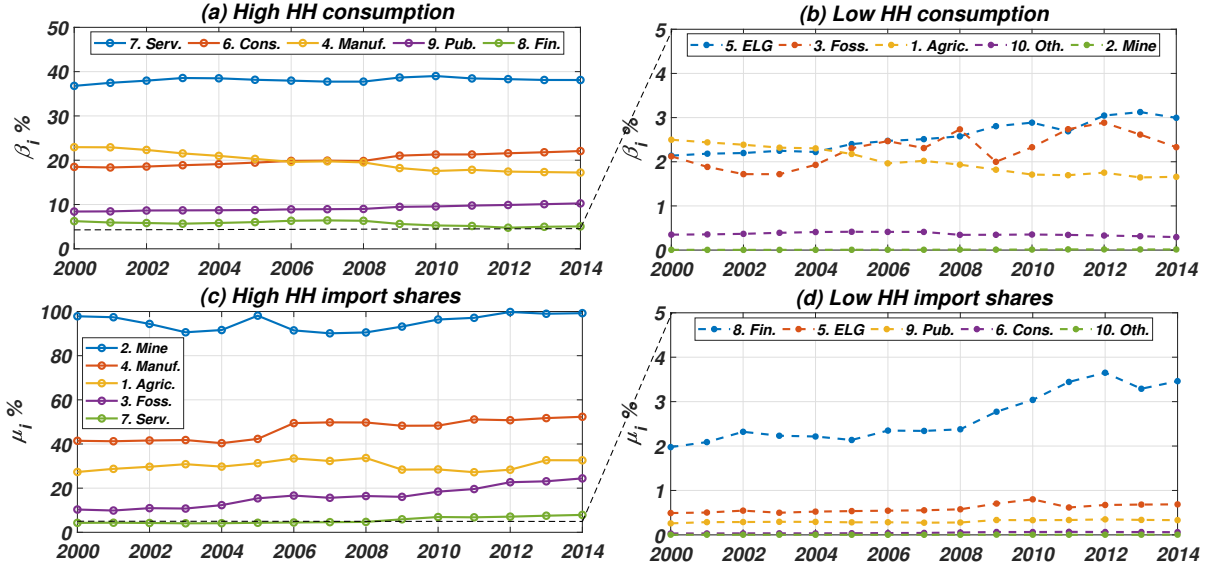

Supplementary Figure 7: Private consumption distribution

Time series of the share of total final private consumption ( $\beta_i$ , top panels) and households imports ( $\mu_i$  bottom panels), by sector, from 2000 to 2014, in France. Source: WIOD 2016 (own calculations).

The two top panels of Supplementary Figure 7 plot the time series of the shares of aggregate consumption directed to each industry. The two bottom panels plot the shares of imports for final consumption by industry from 2000 to 2014. The graphs show approximately constant shares, particularly among industries that have high shares of domestic and import consumption (the two Left panels). Thus, domestic and import consumption is split between industries in constant coefficients expressed by  $\beta_i$  and  $\mu_i$ , respectively, presented in Supplementary Table 11. Households decide how much to consume over the year in relation to their expected (rather than actual income) for that year. We assume that households expect their income to be equal to their realized income of the previous year. Incorrect expectations do not affect current consumption, showing up instead as unforeseen changes in deposit holdings.<sup>35</sup> The propensities to consume out-of-income ( $\alpha_j^y$ ) and out-of-wealth ( $\alpha_j^v$ ) have the following values:

$$\begin{aligned} \alpha_L^y &= 0.90, & \alpha_M^y &= 0.85, & \alpha_H^y &= 0.80; \\ \alpha_L^v &= 0.05, & \alpha_M^v &= 0.045, & \alpha_H^v &= 0.04; \\ \alpha_{cap}^y &= 0.80, & \alpha_{cap}^v &= 0.02; \end{aligned}$$

where the subscript *cap* represents capitalists and *L*, *M*, *H* the three skill-levels.

<sup>35</sup>This Modigliani consumption function implies that households aim to achieve a certain target ratio between their stock of wealth and their flow of income (Godley and Lavoie, 2016, p. 77).

**Supplementary Table 11: Households consumption distribution**

France	Agric.	Mine	Foss.	Manuf.	ELG	Cons.	Serv.	Fin.	Pub.	Oth.
$\mu_i$ (%)	30.3	95.1	16.2	46.7	0.6	0.0	5.4	2.6	0.3	0.0
$\beta_i$ (%)	2.0	0.01	2.3	19.7	2.6	20.1	38.1	5.7	9.2	0.39

Share of total private consumption among industry ( $\beta$ ) and quota of private imports by sector ( $\mu$ ), averaged from 2000 to 2014, in France. Source: WIOD 2016 (own estimations).

Supplementary Table 11 reports the average of  $\mu$  and  $\beta$ , by industry, over the period 2000-2014. Most of private expenditure is directed to services (38.1%), construction (20.1%) and manufacturing (19.7%), while imports concentrates in manufacturing (46.7%) and agriculture (30.3%).<sup>36</sup>

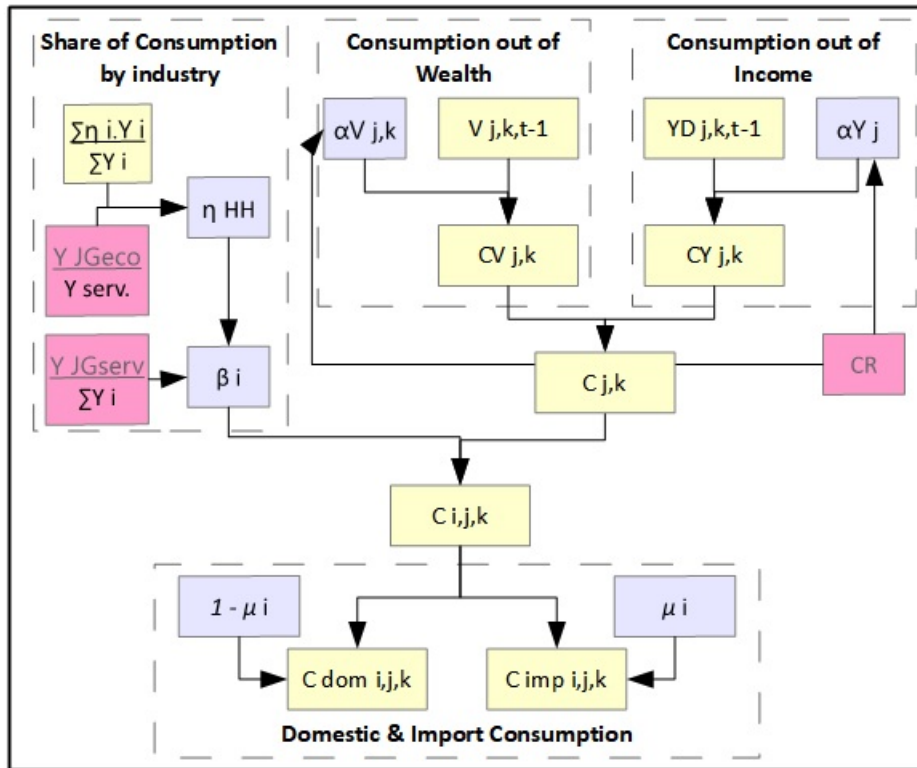

**Supplementary Figure 8: Illustration of the Consumption Module**

The variables in the pink boxes represent policies simulated in the model.  $CR$  is the consumption reduction simulated in the *degrowth* policy-mix which reduces marginal propensities to consume out of income and wealth. Subscript  $k$  here indicates capitalists.

The model also considers two exceptions to the fixed proportions of consumption directed to each industry ( $\beta_i$ ). The share of consumption from the two energy-supplying industries is a decreasing function of households energy efficiency ( $\eta^{HH}$ ). The latter is an average of the energy efficiency of the 10 productive industries weighted by their respective outputs and, thus, reflects the average energy efficiency of the economy. Moreover, workers in the Job-Guarantee program, when it is simulated, are allocated to public services ( $Y_{serv}^{JG}$ ) and environmental activities ( $Y_{eco}^{JG}$ ). The

<sup>36</sup>Despite the high share of imports from the mining sector, we do not mention it because its total private consumption is almost zero.

output of these activities affect households energy efficiency and their consumption of private services according to the following equations:

$$\eta_t^{HH} = \bar{\eta}_t \cdot \left(1 + \frac{Y_{eco,t-1}^{JG}}{\sum_i Y_{i,t}}\right) \quad (59)$$

$$\beta_{k,t} = \beta_k^0 \cdot \frac{\eta_0^{HH}}{\eta_{t-1}^{HH}} \quad (60)$$

$$\beta_{serv,t} = \beta_{serv}^0 \cdot \left(1 - \min\left(\frac{Y_{serv,t-1}^{JG}}{Y_{serv,t-1}}, 0.25\right)\right) \quad (61)$$

where  $\bar{\eta}_t$  is the average energy efficiency of the economy, subscript  $k = [ELG, C19]$  represents the two energy-supplying industries, subscript  $serv$  the service industry defined in Supplementary Table 2 and 0 indicates the initial values of households energy efficiency and of the consumption shares  $\beta$ . The  $min$  function, in the last equation above, determines the upper limit to which public services performed by workers in the Job Guarantee program can substitute private services.

The reductions in consumption shares entailed by the equations above result in an increase of the consumption shares of other industries. Therefore, efficiency gains, despite having a positive direct environmental impact, make room for a rebound effect in consumption that is diverted to other industries. The domestic and import consumption of households by skill  $j$  and industry  $i$  is defined as:

$$C_{i,j,t}^{dom} = \beta_{i,t} \cdot (1 - \mu_i) \cdot (\alpha_j^Y \cdot YD_{j,t-1} + \alpha_j^V \cdot V_{j,t-1}) \quad (62)$$

$$C_{i,j,t}^{imp} = \beta_{i,t} \cdot \mu_i \cdot (\alpha_j^Y \cdot YD_{j,t-1} + \alpha_j^V \cdot V_{j,t-1}) \quad (63)$$

Capitalists' consumption is obtained in a similar fashion applying the same equation to their specific marginal propensities to consume, disposable income, and wealth.

## 1.9 Investments, prices and profits

### Profits

In national accounts, industry value added ( $VA^i$ ) is defined as the difference between the value of output and domestic and imported intermediate costs ( $Z_{i,t} = \sum_k Z_{k,i,t}^{dom} + \sum_k Z_{k,i,t}^{imp}$ ). Namely

$$VA_{i,t} = y_{i,t} - \hat{Z}_{i,t}. \quad (64)$$

Profits ( $\hat{\Pi}_i$ ), net of value added taxes, are given by the difference between value added and labour costs given by the gross wage bill incremented by employers social contributions.

$$\widehat{\Pi}_{i,t} = VA_{i,t} - VAT_{i,t} - (GWB_{i,t} + D613_{i,t}). \quad (65)$$

The *Eurogreen* model includes the actual schedule of the French government to set the corporate income tax rate ( $\tau_{CIT}$ ) from its initial value of 33% in 2014 to 25% by 2022.<sup>37</sup> A constant quota ( $div = 0.3$ ) of net profits ( $\Pi^i$ ) is distributed among households as dividends ( $DIV^i$ ) according to their equity holdings (see subsection 1.5).

<sup>37</sup>The schedule predicts an initial reduction to 31% in 2019, followed by further tax cuts to 28%, 26.5% and finally 25% in 2020, 2010 and 2022, respectively.

$$\Pi_{i,t} = \hat{\Pi}_{i,t} \cdot (1 - \tau_{CIT}), \quad (66)$$

$$DIV_{i,t} = div \cdot \max(\Pi_{i,t}, 0). \quad (67)$$

## Investments, Loans and Equity

Investment behavior is modelled according to the post-Keynesian tradition. Industries invest such that their desired productive capacity, which depends on fixed capital, is enough to supply their demand at normal capacity utilization levels. However, the investment capacity of industries is limited by their profits which determines how much private debt they are able to obtain to finance investments. Desired investments ( $I^*$ ) is a function of capacity utilization ( $uc_{i,t}$ ), profit rates ( $\pi$ ), depreciation rates ( $\delta$ ) for the replacement of fixed capital and of an exogenous fixed parameter ( $\varphi$ ) which represents investments that do not increase productive capacity.

The capacity utilization rate ( $uc_{i,t}$ ) is the ratio between an industry's output ( $y_{i,t}$ ) and its full capacity output ( $y_{i,t}^{FC}$ ), that is "the output achieved with normal length of working time, with sufficient shut-downs to allow for repairs and maintenance, and without disturbance in the smooth running of the production process" (Lavoie, 2014, p.148) instead of the maximum possible output that might be achieved. The full capacity output is proportional to the current stock of fixed capital multiplied by its productivity ( $\epsilon_{K,i}$ ). This coefficient, in turn, is calculated as the product between the (initial) real capital-output ratio ( $k_i^0/y_i^0$ ) and the normal capacity utilization rates ( $uc_i^N$ ) using data from EU-KLEMS.

$$uc_{i,t} = \frac{y_{i,t}}{y_{i,t}^{FC}}, \quad (68)$$

$$y_{i,t}^{FC} = \epsilon_{i,K} K_{i,t}, \quad (69)$$

$$\epsilon_{i,K} = \frac{y_i^0}{K_i^0 \cdot uc_i^N}. \quad (70)$$

The capital rate of return ( $\pi = \Pi/K$ , where  $\Pi$  is the post-tax profit) and the rate of capital depreciation ( $\delta$ ) positively affect investments.<sup>38</sup> Finally, the introduction of the exogenous investment parameter ( $\varphi$ ) follows recent development in the post-keynesian literature that considers investments that do not increase productive capacity as a crucial component of the investment functions (Freitas and Serrano, 2015; Lavoie, 2016; Hein, 2018). Expenditure that increases demand without subsequent, direct, impacts on the growth of productive capacity such as housing, research and development, military expenditure and exports have a fundamental role to stabilize a growth process that converges towards a normal level of capacity utilization, thus providing a solution for Harrodian instability (Serrano et al., 2019). The relevance of an autonomous component in aggregate demand has been recently analysed in stock-flow models (Brochier and Silva, 2018) and empirical studies (Leamer, 2007; Girardi and Pariboni, 2016). The equation for desired investment by an industry is given by:

$$I_{i,t}^* = (\zeta_{i,1} \cdot \pi_{i,t} + \zeta_{i,2} \cdot (uc_{i,t-1} - uc_i^N) + \varphi_i + \delta_i) \cdot K_{i,t-1} \quad (71)$$

where  $\zeta_{i,1}, \zeta_{i,2} \in [0, 1]$  are positive parameters.<sup>39</sup>

Desired investment is constrained by industries capacity to (partially) finance investments with their own profits. Thus, we assume that a share of the profits after debt repayment and taxes ( $\Pi_{i,t}$ ) determine the maximum investment

<sup>38</sup>In the *Eurogreen* model the industry capital depreciation rates, calculated from EU-KLEMS data, are: [0.0134, 0.0035, 0.016, 0.0216, 0.014, 0.0037, 0.0252, 0.0093, 0.01, 0.01]. These values are associated following the order of industries are described in Supplementary Table 2 in the subsection 1.3.

<sup>39</sup>The sensibility parameters in the *Eurogreen* model are calibrated as:  $\zeta_{1,i} = [0.01, 0.1, 0.01, 0.1, 0.1, 0.1, 0.1, 0.1, 0, 0]$ ; and  $\zeta_{2,i} = [0.125, 0.125, 0.125, 0.075, 0.025, 0.05, 0.075, 0.125, 0.05, 0]$ . These values follows the order of the sectors are described in Supplementary Table 2 in the subsection 1.3.

an industry can perform ( $I_i^{max}$ ) together with a fixed debt-to-equity ratio ( $edr = 0.133$ ).<sup>40</sup> In other words, any industry must have the free cash flow to finance at least around 15%  $\approx 0.133/(1 - 0.133)$  of total investments out of its profits while the rest is financed by new loans.

Since desired investment is defined in real terms, the maximum investment is deflated by the price of capital ( $p_t^K$ ).<sup>41</sup>

$$I_{i,t}^{max} = \frac{\Pi_{i,t}}{p_t^K \cdot edr} \quad (72)$$

The initial stock of debt ( $H^0$ ) is determined by the initial values of fixed capital and equity ( $Eq^0$ ). Industries equity and its emission is defined as an aggregate. Since industries do not accumulate profits and instead repay old debt at each period if they have extra profits after investments.<sup>42</sup> The asset side of industries balance-sheet is given by their fixed capital only. Then the initial debt is split between industries according to the share of their capital stock in total capital.

$$H^0 = \sum_i K_i^0 - Eq^0 \quad (73)$$

$$H_i^0 = H^0 \cdot \frac{K_i^0}{\sum_i K_i^0} \quad (74)$$

The dynamics of private debt in each industry then depends on their nominal investments minus the amount financed by profits.

$$H_{i,t} = H_{i,t-1} + I_{i,t}^{nom} - \tilde{\Pi}_t, \quad (75)$$

$$I_t^{nom} = p_t^K \cdot I_t, \quad (76)$$

where  $I_t^{nom}$  is the nominal investment and  $\tilde{\Pi}_t$  are the extra profit available. Note that in this set-up the limits imposed by profit availability also have a dynamic effect on investments. An increase in investment in period  $t$  also raises private debt and, consequently, the amount of future profits that will be allocated to repay it, thus leaving less free cash-flow to finance investments in  $t + 1$ . The actual gross fixed capital formation is defined as the minimum between desired and maximum possible investment that can be financed, namely:

$$I_t = \min(I_t^*, I_t^{max}) \quad (77)$$

The nominal capital stock dynamic is an increasing function of actual investments, previous period capital stock less the exogenous, non-capacity generating investment and capital depreciation.

$$K_{i,t} = K_{i,t-1} + I_{i,t} - (\varphi_i + \delta_i) \cdot K_{i,t-1}. \quad (78)$$

The issuance of new equities by all industries is determined by the increase in capital stock that is not covered by new loans.

$$Eq_t = Eq_{t-i} + \sum_i I_{i,t}^{nom} - \sum_i \Delta H_{i,t} \quad (79)$$

<sup>40</sup>Debt repayment is assumed to be equal to the amount consumed by other industries from the financial sector determined in the input-output matrix ( $\sum_i Z_{fin,i}$ ).

<sup>41</sup>The price of capital is a weighted average of the prices of three industries: manufacturing, construction, and services (n. 4, 6, and 7 of Supplementary Table 2, respectively). Their respective weights are 0.1624, 0.4616 and 0.376 which approximately correspond to the share of goods and services demand for gross capital formation in the whole economy, based on WIOD data for France in 2014. The remaining industries supply a small part of goods and services that compose investments and are, therefore, set to zero.

<sup>42</sup>Having extra profits is equivalent to having more profits than those required for desired investments.

The main variable determining investments are summarized in Supplementary Figure 9.

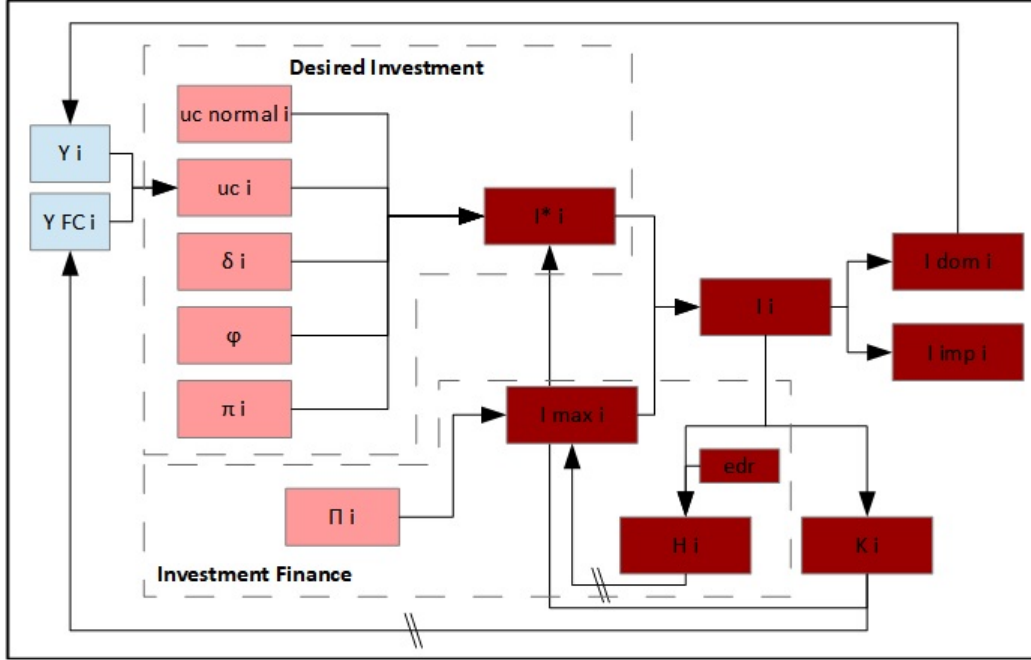

Supplementary Figure 9: Illustration of the Investment Module

The diagonal bars indicate lagged effects, while the other symbols are defined in equations (68), (71), (77) and (78).

## Prices

The *Eurogreen* model assumes that industries impose a *mark-up* on the unit cost of production to set prices. The unit full cost ( $UFC_i$ ) is the sum of the unit post-tax labour cost ( $ULC_i$ ) and unit intermediate inputs cost ( $UIC_i$ ). The  $ULC$  is given by the gross wage bill ( $GWB_i$ , see Eq. (11)) incremented by employers social contribution ( $D613_i$ ) divided by industry output.<sup>43</sup>  $UIC_i$  is the sum of the intermediate goods purchased by industry  $i$  from the each other industry domestically or abroad ( $\hat{Z}_{i,t} = \sum_k Z_{k,i,t}^{dom} + \sum_k Z_{k,i,t}^{imp}$ ) and capital depreciation.

$$UFC_{i,t} = ULC_{i,t} + UIC_{i,t}, \quad (80)$$

$$ULC_{i,t} = \frac{\sum_j GWB_{i,j,t-1} + D613_i}{y_{i,t-1}}, \quad (81)$$

$$UIC_{i,t} = \frac{\hat{Z}_{i,t-1} + \delta_i \cdot K_{i,t-1}}{y_{i,t-1}}. \quad (82)$$

Initial mark-ups ( $\mu_i^0$ ) are positively affected by labour productivity growth ( $g_{\lambda_i}$ ), variations in capacity utilization and value added tax rates ( $\tau_i^{VAT}$ ). We further assume that prices are rigid downward with respect to capacity. That is,

<sup>43</sup>The tax rate of social contributions in the ten industries is equal to  $\sum_i z'_{i,i,t-1} = [0.4313, 0.3991, 0.6987, 0.372, 0.8171, 0.2596, 0.3186, 0.4355, 0.5065, 0.1706]$ . These values follow the order of the sectors described in Supplementary Table 2.

industries do not reduce prices if capacity utilization falls. The equation describing mark-ups ( $\mu_i^t$ ) is:

$$\mu_{i,t} = \mu_i^0 \cdot (1 + \kappa_i \cdot g_{\lambda_i,t-1} + \max(uc_{i,t-1} - uc_i^N, 0) + \tau_i^{VAT}) \quad (83)$$

where  $\kappa_i$  is a constant positive parameter to weight the impact of labour productivity change on final price.<sup>44</sup> The price set by each industry is then given by:

$$p_{i,t} = (1 + \mu_{i,t}) \cdot (UFC_{i,t}) \quad (84)$$

The consumer price index is then calculated as a weighted average of industry prices. The weights are given by the share of consumption directed to each industry ( $\beta_i$ ):

$$CPI_t = \sum_i \beta_i p_{i,t} \quad (85)$$

The main variables regarding prices and profits are presented in Supplementary Figure 10.

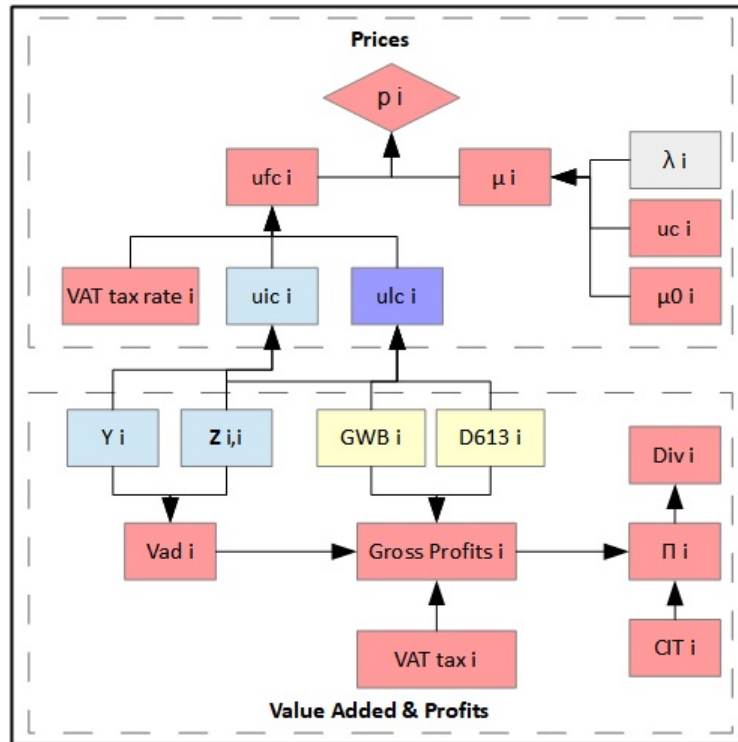

Supplementary Figure 10: Illustration of the Prices and Profits Module

## 1.10 Energy and greenhouse gas emissions

### Energy supply

The *Eurogreen* model considers four energy sources: gas, oil, coal, and electricity. Electric power generation is, in turn, produced with nuclear, renewable, gas, coal, and oil. Supplementary Table 12 shows the shares of energy sources for total primary energy supply (*TPES*) and electricity generation in France in 2014.

<sup>44</sup>In the *Eurogreen* model the parameter  $\kappa_i$  is calibrated as: [10, 10, 50, 50, 50, 50, 30, 30, 0, 0]. These values follows the order of the sectors are described in Supplementary Table 2 in the subsection 1.3.



**Supplementary Table 12: Shares of energy sources on TPES and EPG (2014)**

France	TPES	Electricity
Coal	3.81%	2.13%
Oil	29.21%	0.37%
Gas	13.32%	2.33%
Nuclear	46.49%	77.37%
Renewable	7.17%	17.8%
Total	244,637 ktoe	564,154 GWh

Source: IEA (<https://www.iea.org/statistics>).

France has the world's highest share of nuclear ( $\sim 77\%$ ) in electricity generation (about 437 TWh). However, President Macron announced in 2018 an energy plan to reduce the share of nuclear in the generation mix to 50% by 2035. As described in subsection 1.6, the innovative process is tied with the dynamic of energy efficiency ( $\eta$ ). In the ten productive industries, energy demand (in Mtoe) is given by the equation below where  $y_i$  is the total industry output.

$$E_i^d = \frac{y_i}{\eta_i} \quad (86)$$

In the *Eurogreen* model there are two energy-supplying sectors: Electricity and Gas (*ELG*, n.5 from Supplementary Table 2) and Fossil Fuels (*C19*, n.3 from Supplementary Table 2). The former is responsible for the whole electricity and gas supply in the economy, while the latter provides all the remaining energy products demanded by other industries. From the input-output tables we recover the amount of intermediate sales from the two energy-supplying industries to all the others. Total energy demand is then covered by these two industries and may also be expressed as:

$$E_i^d = E_{ELG,i} + E_{C19,i} \quad (87)$$

We can then express these demands in term of the demand for energy sources of the two energy-supplying industries.

$$E_{ELG,i} = E_{ELG,i}^{el} + E_{ELG,i}^{gas} \quad (88)$$

$$E_{C19,i} = E_{C19,i}^{coal} + E_{C19,i}^{oil} \quad (89)$$

The energy efficiency technical coefficients in matrix **A** of the input-output model are affected by technological progress through the change in  $\eta$  and in the energy mix. Thus, if the share of fossil fuels is reduced due to an energy-saving innovation, the intermediate trade from C19 to all of the other industries falls for a given level of output. The monetary amount of inter-industry trade from seller  $i$  to the buyer  $k$  is defined as  $Z_{i,k}$ . For the two energy industries, we rewrite it as the product of the unitary price of the energy source ( $p_e$ ) and the total (physical) amount of energy traded, namely  $Z_{i,j} = p_e \cdot E_{i,j}$ . Note that,  $p_e$  represents an average price of all the types of energies supplied by the two energy industries represented by subscript  $k$ . Their corresponding technical coefficients can be written as:

$$a_{k,i} = \frac{Z_{k,i}}{y_i} = \frac{E_{k,i}}{y_i} \cdot p_e, \quad \text{for } k \in \{ELG, C19\}. \quad (90)$$

The total amount of energy demanded by each industry ( $E_i^d$ ) can be decomposed by energy source. Then,  $E_i^d =$

$E_j^{ELG} + E_j^{C19}$  can be rewritten in terms of share of energy source as:

$$E_i^d = (\gamma_i^{oil} + \gamma_i^{coal})E_i^d + (\gamma_i^{gas} + \gamma_i^{el})E_i^d = (\gamma_i^{C19})E_i^d + (\gamma_i^{ELG})E_i^d \quad (91)$$

Where  $\gamma_i^{oil} + \gamma_i^{coal} + \gamma_i^{gas} + \gamma_i^{el} = 1$ . Hence, changes in the energy mix, energy efficiency, and energy prices affect the dynamics of the technical coefficients of the two energy-supplying industries as:

$$a_{ELG,i} = p_{ELG} \frac{\gamma_i^{ELG}}{\eta_i}, \quad (92)$$

$$a_{C19,i} = p_{C19} \frac{\gamma_i^{C19}}{\eta_i}. \quad (93)$$

This procedure allows us to directly connect the effects of technological progress on energy efficiency to the productive structure of the simulated economy described by the technical coefficients. Fossil energy and Electricity are also demanded by *households*. For the sake of simplicity, we assume that the share of energy consumption by households going to each source is exogenous. The demand of energy changes according to the growth in the average energy efficiency ( $\bar{\eta}$ ) and the environmental services provided by *Job Guarantee* programme, as explained at the end of Section 1.8.

Supplementary Table 13 breaks down the initial energy consumption by industry and source in the model. The main energy-demanding sectors are electricity and gas, manufacturing, and services. The main sources demanded are electricity and oil that account for about a half and one-third of the total demand, respectively.

**Supplementary Table 13: Energy mix by industry (2014)**

France	Tot (ktoe)	coal	oil	gas	elect.
<b>Agriculture</b>	4,538	0.00%	76.33%	3.77%	19.90%
<b>Mining</b>	169	0.00%	48.52%	14.79%	36.69%
<b>Fossil Fuel</b>	5,273	20.57%	14.94%	4.68%	58.26%
<b>Manufacturing</b>	40,728	10.10%	35.74%	28.06%	22.98%
<b>Electricity</b>	85,909	2.43%	3.03%	4.35%	90.20%
<b>Construction</b>	1,027	0.00%	57.35%	24.73%	17.92%
<b>Services</b>	49,535	0.00%	91.78%	0.19%	8.03%
<b>Finance</b>	2,362	0.77%	11.59%	30.48%	57.16%
<b>Public</b>	18,671	0.77%	11.59%	30.48%	57.16%
<b>Other</b>	40,436	0.77%	11.59%	30.48%	57.16%
<i>Total (Ktoe)</i>	<b>248,648</b>	<b>7,752</b>	<b>74,668</b>	<b>34,701</b>	<b>131,527</b>
<i>Total (%)</i>	<b>100.00</b>	<b>3.12%</b>	<b>30.03%</b>	<b>13.95%</b>	<b>52.90%</b>

TPES in ktoe (of oil equivalent) by industry and composition by source of energy. Source: *Eurostat* - Energy Balances (own calculations).

Supplementary Table 14 compares the total energy consumption by energy source simulated in the baseline scenario of the model with the values projected in the “EU Reference scenario to 2050” (Capros et al., 2016). Although the values are very similar for 2020 their difference grows over time. Our baseline simulation projects lower energy consumption from all sources but solids by 2050. Those differences may be attributed to the significantly lower GDP growth rates projected in the *Eurogreen* model with respect to the official EU projections (see Supplementary Table 21).

**Supplementary Table 14: Energy use distribution by source**

Sources	2020	2030	2040	2050
Solid	8,234	7,545	6,242	4,918
	<i>8,492</i>	<i>5,012</i>	<i>3,116</i>	<i>2,134</i>
Oil	80,246	78,676	67,375	51,731
	<i>75,372</i>	<i>71,292</i>	<i>68,998</i>	<i>66,983</i>
Gas	38,800	36,340	28,840	22,076
	<i>35,944</i>	<i>32,194</i>	<i>36,029</i>	<i>33,460</i>
Electricity	130,500	118,000	92,840	70,290
	<i>129,034</i>	<i>128,035</i>	<i>111,330</i>	<i>105,323</i>

Comparison of energy consumption by source (in Ktoe) in the baseline scenario as simulated in the *Eurogreen* model (black) and in the “EU reference scenario 2016 - Energy, transport and GHG emissions trends to 2050” (Capros et al., 2016) (blue/italic).

## Greenhouse gas emissions

The *Eurogreen* model recovers the greenhouse gas emissions,<sup>45</sup> by source and industry, from the Eurostat database.<sup>46</sup> The main pollutant sources are aggregated into solid, liquid and gas; each one with a different factor of conversion from their physical amount of energy in CO<sub>2</sub> emissions. Data for conversion are provided by the “Réseau de transport d’Électricité”,<sup>47</sup> that returns the following factor of conversion in tons of CO<sub>2</sub> per unit of energy (MWh): 0.96 t/MWh for solid, 0.67 t/MWh for oil, and 0.46 t/MWh for gas.

Total CO<sub>2</sub> emissions are either subject to the carbon taxes described in the main text or allocated to the European Union Emission Trading System (EU-ETS). The freely allocated allowances of firms belonging to the EU-ETS, in France in 2014, were about 80,458 kton of CO<sub>2</sub> equivalent, while their actual emissions were around 114,547 ktoe.<sup>48</sup>

In order to calibrate and verify the robustness of the model outcomes, in terms of environmental performances, we present an empirical analysis of the main drivers of greenhouse gas emissions. We employ data from WIOD to perform a structural decomposition analysis (SDA) to break down into seven key drivers France yearly CO<sub>2</sub> emissions variation to highlight how structural changes, as modelled in *Eurogreen*, might affect GHG emissions.<sup>49</sup> Let us define the *Leontief technique* here implemented. It considers both the direct and the indirect industry linkages that can be further decomposed into the effects of a change in the product-mix (*LH*) and in international trade (*LT*). The existing literature suggests that this dynamics has been driven by a variety of factors such as changes in carbon efficiency, structural change, the composition of final demand and scale effects (Xu and Dietzenbacher, 2014; Distefano et al., 2018).

From a methodological perspective, the *SDA* offers a static comparative analysis that allows quantifying the variation in energy requirements because of a change in one of the drivers while keeping all the others unchanged (also called *ceteris paribus* condition). The relative change of total CO<sub>2</sub> from time *t* to *t* + 1 may be described as:

$$\Delta CO_2 = \zeta(IE; T; H; DT; MIX; CAP; POP) \quad (94)$$

<sup>45</sup>Greenhouse gases includes direct CO<sub>2</sub> and all the other air pollutants (N<sub>2</sub>O, CH<sub>4</sub>, HFC, PFC, SF<sub>2</sub>, and NF<sub>3</sub>) in CO<sub>2</sub> equivalent.

<sup>46</sup>see [http://appsso.eurostat.ec.europa.eu/nui/show.do?dataset=env\\_air\\_gge&lang=en](http://appsso.eurostat.ec.europa.eu/nui/show.do?dataset=env_air_gge&lang=en).

<sup>47</sup>See <https://www.rte-france.com/fr/eco2mix/eco2mix-co2>.

<sup>48</sup>see <https://www.eea.europa.eu/data-and-maps/dashboards/emissions-trading-viewer-1>. Total emissions from productive industries were 326,155 ktoe.

<sup>49</sup>In this case we rely on the Release 2013 instead of the latest version since the latter presents no environmental data.

The intensity effect (*IE*) refers to changes in CO<sub>2</sub> per unit of output, *T*, and *H* represent the effects of trade and of the industry composition of intermediate inputs, respectively, captured by the Leontief inverse. The impact of final demand is decomposed into four components: international trade (*DT*), change in the product mix (*MIX*), change in consumption (or income) per capita (*CAP*) and population size (*POP*).

Supplementary Figure 11 shows the cumulative change in CO<sub>2</sub> emissions, from 1995 to 2009, of each component with respect to the base year (1995). The left panel shows an overall increase in GHG emissions in France of about 30% in 15 years. The contribution of the technological progress (*IE*) component has been rather small in the first years of the series (1995-2002) and then accelerated substantially until 2009.<sup>50</sup> However, this impact was more than offset by the rapid increase in consumption (blue line) and by the evolution of production-mix defined by the intermediate trade (green line). The central panel of Supplementary Figure 11 shows in greater detail the impact of intermediate goods trade. The component *H* should be interpreted as the contribution to emissions of a variation in the mix of intermediate inputs bought with no consideration of their geographical origin. A positive sign reveals a systematic increase in the relative importance of CO<sub>2</sub>-intensive industries. Overall, this component has driven up French emissions by about 15% over the period 1995-2009. The component *T* accounts for changes in the ‘geographical’ composition of the mix of intermediate inputs (i.e., *LH*). A positive sign should be interpreted as a systematic shift of the purchase of intermediates towards more CO<sub>2</sub>-intensive countries. At the aggregate level, this component is very small (5%) but contributed to increase emissions.

The right panel of Supplementary Figure 11 shows the impact on emissions related to the four components of final

<sup>50</sup>Note that in this case the percentage is smaller than 100% because each variation is computed with respect to the previous year, and each year showed an increase in GHG emissions. An example might clarify: let assume that the air pollution is constant over time at 100 Mton, and assume that there are only two factors that influence CO<sub>2</sub>: *x* and *y*. Let imagine that each year *x* contributes *ceteris paribus* to an increase of 20 Mton that are exactly compensated by *y*. Then if we compute the cumulative variation, with respect to the value of the first year (100), we would obtain values smaller than 100% from the sixth year onward (i.e., 120%) for the factor *y*.

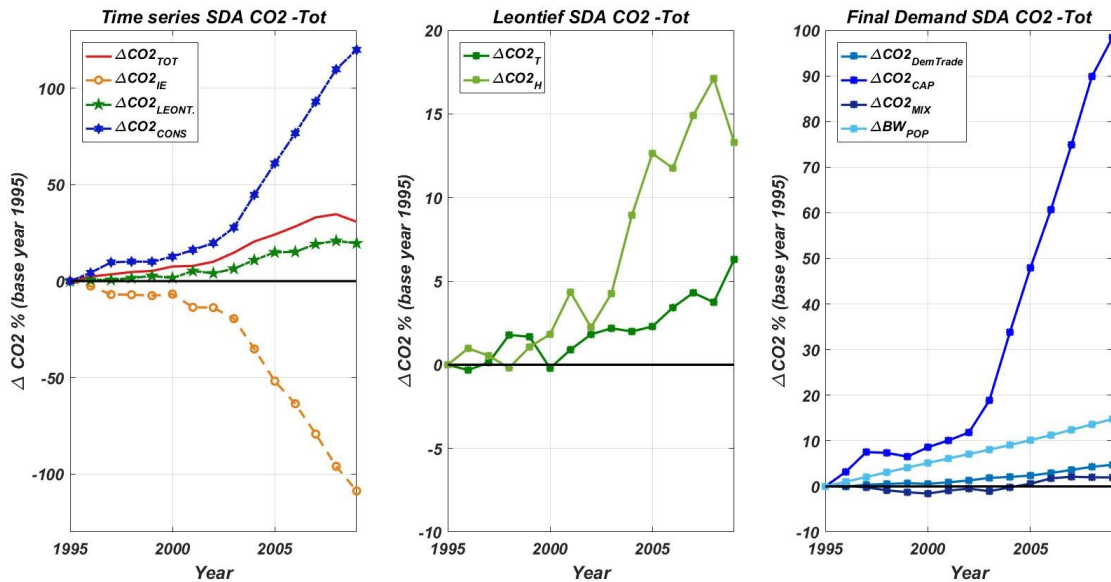

**Supplementary Figure 11: Structural decomposition analysis of the total GHG emissions**

Left panel includes the three main categories: carbon intensity (*IE*), Leontief effect (Leont.), and final demand (Cons.). Central panel shows the decomposition of the Leont. effect in *T* (international trade) and *H* (product-mix); while the right panel shows the decomposition of the Cons. in international trade (*Dem. Trade*), income per capita (*CAP*), consumption mix (*Mix*), and population growth (*Pop*), from 1995 to 2009 in France.

demand. The component *MIX* quantifies the role played by changes in the product mix of final demand for a given level and geographical composition of it. We find that it had almost no role in the time window considered. The *DT* component contributed (slightly) positively to the overall emissions (about 5%). The last two components refer to more aggregate driving forces: changes in total final demand per capita (in real terms) and demographic growth. The role played by changes in *CAP*, which is strongly correlated with affluence, is very important. Final demand per capita is by far the largest component that drives CO<sub>2</sub> emissions. The population showed a further positive impact of about 15%.

## 1.11 Public sector

The public sector in the *Eurogreen* model corresponds to the general government sector (S13) in the national accounts. That is, it excludes public corporations, and with them most of the market output of the real-world public sector. By definition, S13 produces mainly non-market output, i.e., the output provided to others “free of charge or at prices that are not economically significant, meaning in practice prices that cover less than half the cost of production” (Lequiller, 2015, p. 114). In national accounting, non-market output is measured at cost, equal to the sum of labour compensation, intermediate consumption, and consumption of fixed capital (Lequiller, 2015, p. 280).<sup>51</sup> The operating surplus (i.e., profits) is virtually zero, due to the exclusion of for-profit public corporations. A further peculiarity of S13 is that its non-market output is largely consumed by itself. As Lequiller explains: “because there are no observable monetary transactions (the services are free of charge), national accountants have given up on the idea of attributing this consumption specifically to households or to firms, and they have attributed it to general government itself” (Lequiller, 2015, p. 281-282).

## Government expenditure and revenue

Supplementary Figure 12 shows the historical time series of the shares of public domestic consumption and import by industry. As for households, these ratios are somewhat stable throughout the period (2000-2014). The average share of domestic and foreign consumption are used to calculate the fixed coefficients that distribute total government consumption between the industries presented in Supplementary Table 15

**Supplementary Table 15: Government consumption distribution**

<i>France</i>	<i>Agric.</i>	<i>Mine</i>	<i>Foss.</i>	<i>Manuf.</i>	<i>ELG</i>	<i>Cons.</i>	<i>Serv.</i>	<i>Fin.</i>	<i>Pub.</i>	<i>Oth.</i>
$\mu_i$ (%)	0.0	0.0	0.0	3.2	0.0	2.8	9.5	0.0	84.4	0.1
$\beta_i$ (%)	2.0	0.0	2.3	19.7	2.6	20.1	38.1	5.7	9.2	0.4

Share of total public consumption among industry ( $\beta$ ) and quota of government imports by sector ( $\mu$ ), averaged from 2000 to 2014, in France. Source: WIOD 2016 (own estimations).

Government *consumption* is defined as  $G^C$  and is composed by government expenditure in: job guarantee when active ( $G^{JG}$ ), investments ( $G^K$ ), transfers and benefits ( $G^{Tr}$ ), wages ( $G^w$ ), interests on bond ( $G^B$ ), and final goods ( $G^f$ ).<sup>52</sup> Hence:

$$G^C = G^f + G^B + G^w + G^{Tr} + G^K + G^{JG} \quad (95)$$

<sup>51</sup>In 2014, non-market output represented 87.4% of the total output of S13, the remainder being market output which “consists of sales by the general government (publications, sales of medicines by hospitals, exports of warships from naval shipyards, sales of water supply by communal syndicates)” (Lequiller, 2015, p. 282).

<sup>52</sup>To be precise, we should refer to the component S13 of the NIOT. Following the conventions of national accounting, the non-market output (P13) of the public sector is assumed to be consumed by the public sector itself, except for partial payments by households. Government consumption of goods and services produced by the market sector is labeled D632. Non-market output (P13), net of partial payments (P131) amounted to about 387,541 million of euro (75% of S13 consumption), while the remaining part was spent in social transfers in kind - purchased market production (D632), for about 128,136 million of euro in 2014.

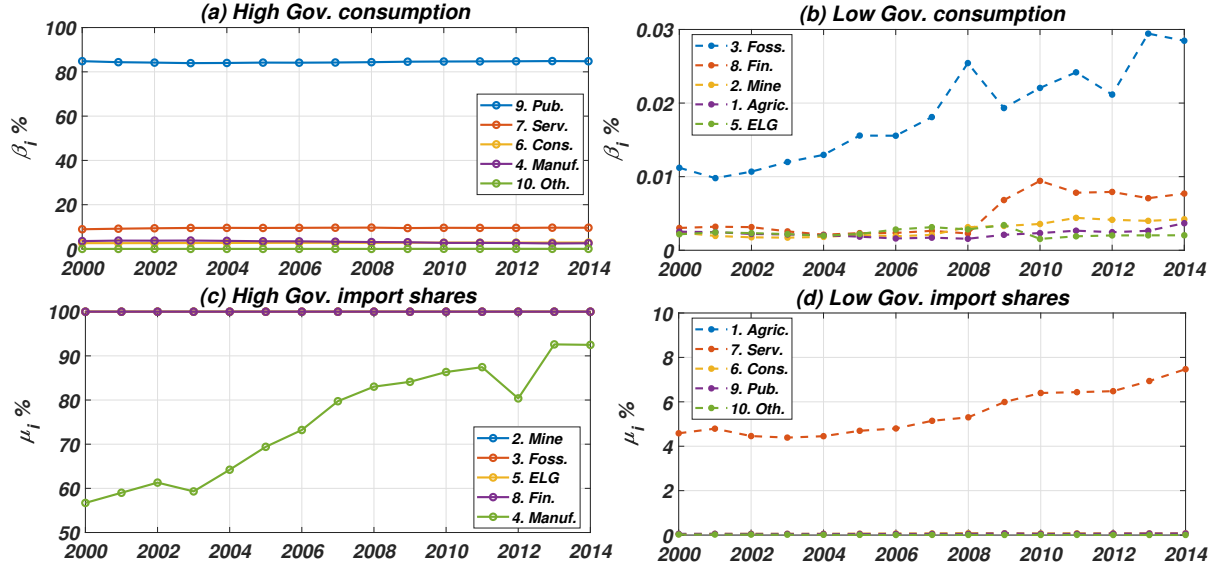

Supplementary Figure 12: Public consumption distribution

Time series of the share of total public consumption (top panels) and government imports (bottom panels), by sector, from 2000 to 2014, in France. Source: WIOD Release 2016 (own calculations).

Public revenues are given by *taxes* ( $G^T$ ) such as: employers social contributions ( $G^{D613}$ ), value added tax ( $G^{VAT}$ ), corporate income taxes ( $G^{CIT}$ ), wealth tax ( $G^V$ ), tax on households ( $G^{HH}$ ), carbon tax ( $G^{CARB}$ ) and border carbon adjustment ( $G^{BCA}$ ).<sup>53</sup> Hence:

$$G^T = G^{D613} + G^{VAT} + G^{CIT} + G^{HH} + G^V + G^{CARB} + G^{BCA} \quad (96)$$

The difference between this two component returns the yearly public *deficit*:

$$G^D = G^C - G^T. \quad (97)$$

The full list of government's sources of expenditure and revenue is summarizes in Supplementary Table 16. We summarize all the components of public expenditure and revenue in the two list below:

On the *expenditure* side:

- $G^{Tr}$  is the total expenditure in social transfers for unemployed, pensioners, inactives, and other social protection transfers (see subsection 1.4);
- $G^w$  is gross wage bill of employed workers in the public sector;
- $G^K$  are the investments in gross fixed capital formation needed to cover the depreciation of installed capital and for new equipment in the public sector (see Section 1.9);
- $G^B$  is the government expenditure on public debt interest (i.e., bond), as described by equation (101) below;
- $G^f$  is the total final consumption of the public sector;<sup>54</sup>

<sup>53</sup>Once again, only if carbon border adjustment tax on imports is simulated.

<sup>54</sup>From NIOT it results that the French total nominal public sector consumption, in 2014, was around €514 billions.

Supplementary Table 16: Government balance: revenue and expenditure sources

Expenditures	Revenues
Government consumption	Value added tax
Wages	labour taxes
Investment	Corporate income tax
Interest on public debt	Progressive income tax
Pensions	<i>Contribution sociale généralisée</i>
Unemployment benefits	<i>Remboursement de la dette sociale</i>
Sickness and disability benefits	Aggregate social contribution
Family and children benefits	Tax on financial income and wealth
<i>Revenu de Solidarité Active</i>	Carbon tax

- $G^{JG}$  is the total expenditure of the job guarantee program whenever it is active, as described in Methods of the main text. It includes wages of newly hired workers that perform specific activities (e.g., social care, ecological services).

Government *revenues* are the following:

- $G^{D613}$  are the inflows from employers social contributions which are payed on the gross wage bill of each industry;
- $G^{VAT}$  is the value added tax. The VAT tax rates vary across industries, but are assumed constant over time. In particular, the values applied in the simulations for the ten *Eurogreen* industry, are: (1) 4.5%, (2) 10%, (3) 20%, (4) 15%, (5) 20%, (6) 12%, (7) 17.7%, (8) 20%, (9) 5.5%, and (10) 10%.
- $G^{CIT}$  is the total corporate income tax. The standard rate is 33.3% of taxable income (28% for up to €500,000 in profits).<sup>55</sup> It is expected to fall to 28% in 2020, and to 25% in 2022.<sup>56</sup>
- $G^{HH}$  is the overall revenue from all taxes payed by households: type *A* and *B* taxes, compulsory social security contributions, and taxes on financial income.
- $G^V$  is based on the European wealth tax (EWT, national accounts indicator D59A).
- $G^{CARB}$  and  $G^{BCA}$  are the environmental taxes imposed to curb greenhouse gas emissions, as described in the main text. Taking into account the recent French National Energy Transition for Green Growth program, which introduced a carbon tax of €7 per ton of CO<sub>2</sub> in 2014. The tax rates increase about €8 per ton of CO<sub>2</sub> per year until 2020 up until €56 in 2020 and €100 per ton of GHG emissions in 2030.<sup>57</sup> The second fiscal instrument introduced is a border carbon adjustment tax that imposes the same carbon tax rates to imports according to their GHG content with the sole exception of agricultural imports.

## Public finance

For government *bonds*, we assume that the nominal demand for bonds is determined by the portfolio choice model (see Section 1.5). French long-term government bonds (*B*) are the only type of bonds included in the model. Therefore, the

<sup>55</sup>See “Recent Developments In French Taxation”, <https://www.lexology.com/library/detail.aspx?g=7eea49a3-3272-4855-a8eb-58ca33a2e6a2>.

<sup>56</sup>Finance Minister Bruno Le Maire “said corporate tax would be cut to 31 percent in 2019, 28 percent in 2020, 26.5 percent in 2021 and 25 percent by the end of Macron’s term in 2022.” (Reuters, “French government outlines gradual corporate tax cut plans”, <https://www.reuters.com/article/us-france-reform/French-government-outlines-gradual-corporate-tax-cut-plans-idUSKCN1BA2HX>).

<sup>57</sup>See law no. 2015-992 on Energy Transition for Green Growth.

total nominal demand for French government bonds is:

$$B^d = B_m + B_h + B_{cap}. \quad (98)$$

According to our calculations based on WID world data, the total nominal stock of bonds (of any kind) held by resident adults in France in 2014 was €632,498 million. The Maastricht-reported public debt of France at the end of 2014 was €2,040,379 million, of which €1,705,069 million in debt securities, further divided into €196,824 million in short-term bills (original maturity up to 1 year) and €1,508,245 million in long-term bonds (original maturity over 1 year or no stated maturity).<sup>58</sup> Of the total debt securities, €883,489 million were held by residents, and the remaining €821,580 million held by the foreign sector.

The bond market is assumed to be in initially in equilibrium. For this purpose, we scale the outstanding stock of debt securities (i.e., the supply of bonds,  $B^S$ ) to the demand for bonds:

$$B^S = \frac{1705069}{632498} B^d = 2.69577 B^d \quad (99)$$

The government determines the outstanding stock of bonds in volume ( $\bar{B}$ ), such that the budget deficit is covered if the bonds sell at the government expected price,  $E(p_{B,t}) = p_{B,t-1}$ . The shortfall (or excess) of funds caused by mistaken expectations is covered by the issuance (or withdrawal) of short-term bill, which do not bear interest by assumption. All short-term bills outstanding are redeemed after one period. Thus, the stock of long-term bonds outstanding at the end of period  $t$ , measured in volume, is equal to the stock at the end of the previous period, plus new borrowing,  $G^D$ , converted into expected volume, plus short-term bill  $Bl$  outstanding at the end of the previous period, also in expected volume:

$$\bar{B}_t = \bar{B}_{t-1} + \frac{G^D + Bl_{t-1}}{E(p_{B,t})} \quad (100)$$

where the price on long-term bonds adjusts to clear the (scaled) market:  $p_B = B^S / \bar{B}$ .

Due to our assumption of initial equilibrium on the bond market, the stock of short-term bills outstanding at the end of 2014 is assumed to be zero, so that the nominal stock of long-term bonds is equal to the €1,705,069 million for total debt securities. Thus, the rate of interest on government bonds is:

$$nr_t^B = nr_{t-1}^B - 0.000166925 \Delta P_{B,t} \quad (101)$$

Following [Godley and Lavoie \(2016, chapter 5\)](#), bonds are modelled as perpetuities that are never redeemed. The pre-tax rate of return on bonds, including real capital gains, is:

$$rr_t^B = \frac{\Delta p_{B,t}}{p_{B,t-1}} - \frac{\Delta CPI_t}{CPI_{t-1}} + nr_t^B \quad (102)$$

where  $CPI$  is the consumer price index. Finally, the post-tax rate of return, which enters the portfolio choice model, is:

$$nrr_t^B = (1 - t^F) rr_t^B \quad (103)$$

where  $t^F$  is the tax rate on financial income (set to 30%).

---

<sup>58</sup>Maastricht-reported public debt is the consolidated debt valued at face value ([Lequiller, 2015, p. 292](#)). In France, long-term bonds are known as Obligations Assimilables du Trésor (OAT), and short-term bills are Bons du Trésor à taux fixe et à intérêts précomptés (BTF). See Agence France Trésor, [http://www.aft.gouv.fr/rubriques/general-information\\_169.html](http://www.aft.gouv.fr/rubriques/general-information_169.html).



## 1.12 Stock-Flow Matrices

This Section presents the balance-sheet and the transaction flow matrices of the model. The variables presented for the different stocks and flows inside each matrix are defined in the previous sections. Given the peculiarities of the financial and public industries, we present them in separate columns while the stocks and flows of the remaining 8 industries are presented together in column ( $ind_i$ ).

As mentioned in Methods in the main text, the model is not fully stock-flow consistent since it considers an open economy without modelling the foreign sector. Additionally, industries included in the EU-ETS pay according to their emissions but no other agent in the model receives such payments. In order to properly address this issue, it would be necessary to model inter-industry transactions which are beyond the scope of the *Eurogreen* model. Still, we opted to model the EU-ETS payments even if they violate stock-flow consistency to include their impact on GHG emissions through energy cost and technological choice.

**Supplementary Table 17: Aggregate Balance sheet**

	Low-skill	Middle-skill	High-skill	Cap.	Ind. <sup>†</sup> <sub><i>i</i></sub>	Fin.	Gov.	$\Sigma$
Deposits	$D_l$	$D_m$	$D_h$	$D_{cap}$		$-D$		0
Bonds		$B_m$	$B_h$	$B_{cap}$			$-B$	0
Equity <sup>1</sup>			$Eq_h$	$Eq_{cap}$		$Eq$		0
Loans					$-\sum_i H_i$	$H$	$-H_9$	0
Fixed Capital					$\sum_i K_i$	$K_8$	$K_9$	$\sum_{i=1}^{10} K_i$
Net worth	$-V_l$	$-V_m$	$-V_h$	$-V_{cap}$				$-V$
$\Sigma$	0	0	0	0	0	0	0	0

<sup>†</sup> Represents all industries with the exception of the financial and public sectors which have specific balance-sheets.

<sup>1</sup> As mentioned in Section 1.9 equity supply is modelled as an aggregate for all industries, given by the sum of equity emissions from investments minus loans from all industries.

Supplementary Table 18: Transaction Flow Matrix

	Low-skill				Middle-skill				High-skill				Capitalists	Industries <sup>†</sup>		Financial		Government		Σ	
	E	U	I	P	E	U	I	P	E	U	I	P		current	capital	current	capital	current	capital		
Wages	Σ <sub>j</sub> $GWB_{j,l}$				Σ <sub>j</sub> $GWB_{j,m}$				Σ <sub>j</sub> $GWB_{j,h}$					- Σ <sub>j</sub> $GWB_j$	- $GWB_8$	- $GWB_9$		0			
Pensions				$GPB_l$				$GUB_m$				$GUB_h$					- Σ <sub>j</sub> $GPB_j$		0		
UB		$GUB_l$				$GUB_m$				$GUB_h$							- Σ <sub>j</sub> $GUB_j$		0		
FCB			$FCB_l$				$FCB_m$				$FCB_h$						- Σ <sub>j</sub> $FCB_j$		0		
SDB			$SDB_l$				$SDB_m$				$SDB_h$						- Σ <sub>j</sub> $SDB_j$		0		
RSA		$RSA^U$	$RSA^I$														- $RSA$		0		
CSG	- $T_l^{A,E}$	- $T_l^{A,U}$	- $T_l^{A,I}$	- $T_l^{A,P}$	- $T_m^{A,E}$	- $T_m^{A,U}$	- $T_m^{A,I}$	- $T_m^{A,P}$	- $T_h^{A,E}$	- $T_h^{A,U}$	- $T_h^{A,I}$	- $T_h^{A,P}$						Σ <sub>j</sub> $T_j^A$	0		
CRDS	- $D613_l^E$	- $D613_l^U$	- $D613_l^I$	- $D613_l^P$	- $D613_m^E$	- $D613_m^U$	- $D613_m^I$	- $D613_m^P$	- $D613_h^E$	- $D613_h^U$	- $D613_h^I$	- $D613_h^P$						Σ <sub>j</sub> $D613_j$	0		
Income tax	- $T_l^{R,E}$	- $T_l^{R,U}$	- $T_l^{R,I}$	- $T_l^{R,P}$	- $T_m^{R,E}$	- $T_m^{R,U}$	- $T_m^{R,I}$	- $T_m^{R,P}$	- $T_h^{R,E}$	- $T_h^{R,U}$	- $T_h^{R,I}$	- $T_h^{R,P}$						Σ <sub>j</sub> $T_j^R$	0		
Financial income tax*							- $T_m^F$				- $T_h^F$		- $T_{cap}^F$					$T^F$	0		
Wealth tax*											- $T_h^W$		- $T_{cap}^W$					$T^W$	0		
Lab. tax															- Σ <sub>j</sub> $D613_j$	- $D613_8$	Σ <sub>j</sub> $D613_j + D613_8$		0		
CIT															- Σ <sub>j</sub> $CIT_j$	- $CIT_8$	Σ <sub>j</sub> $CIT_j + CIT_8$		0		
Carbon tax															- Σ <sub>m</sub> $CT_m$	- $CT_8$	Σ <sub>m</sub> $CT_m + CT_8$		0		
ETS															- Σ <sub>n</sub> $ETS_n$			Σ <sub>n</sub> $ETS_n$	0		
VAT															- Σ <sub>j</sub> $VAT_j$	- $VAT_8$	Σ <sub>j</sub> $VAT_j + VAT_8$		0		
Profits* <sup>1</sup>									$\varphi_h^{div} (Div_l + Div_h)$				$\varphi_{cap}^{div} (Div_l + Div_h)$		- Σ <sub>j</sub> $\Pi_j$	Σ <sub>j</sub> $\Pi_j^{res}$	- $\Pi_8$	$\Pi_8^{res}$	0		
Intermediate goods															Σ <sub>j</sub> (Σ <sub>m</sub> $Z_{m,j} - \Sigma_l Z_{m,l} - \Sigma_l Z_{m,l}^{imp}$ )	Σ <sub>j</sub> $Z_{8,j} - \Sigma_m Z_{m,8} - \Sigma_m Z_{m,8}^{imp}$	Σ <sub>j</sub> $Z_{9,j} - \Sigma_m Z_{m,9} - \Sigma_m Z_{m,9}^{imp}$	Σ <sub>i=1}^{10} \Sigma_{m=1}^{10} <math>Z_{m,i}^{imp}</math></sub>	0		
Consumption* <sup>2</sup>		- Σ <sub>j</sub> $C_{l,j}$				- Σ <sub>j</sub> $C_{m,j}$				- Σ <sub>j</sub> $C_{h,j}$				- Σ <sub>j</sub> $C_{cap}$	Σ <sub>j</sub> $C_j^{dom} + \chi_i$		$C_8^{dom}$		$\chi - \Sigma_l C_l^{imp}$	0	
Investments															Σ <sub>j</sub> $I_k^{dom}$	- Σ <sub>j</sub> $I_l$		- $I_8$		- Σ <sub>k</sub> $I_k^{imp}$	0
Interest on bonds*							$i^B \varphi_m B$				$i^B \varphi_h B$		$i^B \varphi_{cap} B$					- $i^B B$		0	
Σ*		$Sav_l$				$Sav_m$				$Sav_h$			$Sav_{cap}$		Σ <sub>j</sub> $\Pi_j^{res} - \Sigma_l I_l$	$\Pi_8^{res} - I_8$	- $Def$		$\chi - M + \Sigma_m ETS_m$	0	
Δ Deposits*		- Δ $D_l$				- Δ $D_m$				- Δ $D_h$			- Δ $D_{cap}$				Δ $D$		0		
Δ Bonds*							- Δ $B_m$				- Δ $B_h$		- Δ $B_{cap}$						Δ $B$	0	
Δ Equities*											- Δ $E_h$		- Δ $E_{cap}$				Δ $E_i$	Δ $E_8$		0	
Δ Loans*															Σ <sub>j</sub> Δ $H_j$		- Σ <sub>j</sub> Δ $H_j$		Δ $H_9$	0	
Δ Capital															- Σ <sub>j</sub> Δ $K_j$		- Δ $K_8$		- Δ $K_9$	- Δ $K$	
Net Worth		Δ $V_l$				Δ $V_m$				Δ $V_h$			Δ $V_{cap}$							Δ $V$	
Σ		0				0				0			0		0				0	$\chi - M + \Sigma_m ETS_m$	

† represents all industries given by subscript  $i$  except financial services (8) and the public sector (9).

Households income and taxes are split between employed (E), unemployed (U), inactive (I) and retired (R) to indicate taxes and benefits specific to each of these occupational statuses.

\* represents flows that are aggregated by skill indicated by the subscript  $j=L$  low,  $M$  middle and  $H$  high-skill.

1 we include residual profits ( $\Pi_i^{res}$ ) to point-out that not all profits are distributed as dividends ( $Div$ ). Profits after dividends are used to finance part of investments as seen in line  $\Sigma = \Sigma_i \Pi_i^{res} - \Sigma_i I_i$ .

2 includes consumption out of wealth.

UB = unemployment benefits, FCB = family and children benefits, SDB = sickness and disability benefits, RSA = *revenu de solidarité active*, CSG = *contribution sociale généralisée*, CRDS = *contribution au remboursement de la dette sociale*, CIT = corporate income tax, VAT = value added tax.

## 2 Supplementary Results

This section briefly describes the single policies that compose the three policy mixes described in the main text and reports the results of each policy mix in terms of five indicators. It then plots the simulation results for these single policies and a comparison between the projections of our baseline scenario and other well known projections from the EU.

### 2.1 Summary of simulated policies

The following two tables present a concise summary of the single policies simulated in the model (Supplementary Table 19) and of the three policy mixes they compose (Supplementary Table 20) presented in the main text. The tables use the following acronyms to characterize each policy:

- ◇ HLP - High labour productivity
- ◇ HEFF - High energy efficiency
- ◇ BI - Basic income
- ◇ JG - Job guarantee
- ◇ WTR - Working time reduction
- ◇ EnM - Energy Mix
- ◇ BCA - Border carbon adjustment
- ◇ CR - Consumption reduction
- ◇ XR - Export reduction
- ◇ Wtax - Wealth tax
- ◇ NPR - Next production revolution
- ◇ GG - Green growth
- ◇ PSE - Policies for social equity
- ◇ DG - Degrowth

Supplementary Table 19: Summary of Individual policies

Policy	Summary	Comment	Real GDP	GHG emissions	Unemp. rate	Gini	Deficif /GDP
HLP	Reduces the labour saving innovation threshold parameter from 0.75 to 0.6 and the joint labour and energy saving threshold from 0.8 to 0.65	Average labour productivity increases about 25% w.r.t. the baseline scenario	~ 0	-	+	+	~ 0
HEEF	Reduces the energy saving innovation threshold parameter from 0.5 to 0.3	Average energy efficiency increases about 16% w.r.t. the baseline scenario	~ 0	-	~ 0	~ 0	~ 0
BI	Introduces a 5,580 yearly benefit to all working age adults that substitutes or reduces other social transfers	A high initial impact on growth a income distribution dissipates in time while deficit remains relatively high.	+	+	-	-	+++
JG	Government hires a maximum of 300,000 unemployed workers per year that perform either services or environmental work and are paid minimum wages	Due to gradual hiring JG has a continued impact on employment and income distribution	+	~ 0	--	--	++
WTR	Weekly working hours are reduced from 35 to 30 in five years	Reduction leads industries to increase hiring, particularly in the five years in which the policy is gradually introduced	-/+	~ 0	-	-	-
EnM	Gradually increases renewable energy sources in electricity generation reducing fossil fuels and nuclear power. It also introduces a process that increases the share of electricity in total energy consumption	Despite being the most effective environmental policy, it only has a mild impact on the other main indicators	~ 0	----	-	-	~ 0
BCA	Imposes additional yearly increases of €4.4 in carbon taxes after 2030, that reach €188 by 2050. Also charges an equivalent tax on imported goods, according to their CO <sub>2</sub> content	Overall carbon taxes have a small impact on the simulations, mostly due to the limited amount of emissions and industries that are subject to these taxes	~ 0	~ 0	-	-	~ 0
CR	Yearly constant reduction of 0.07 in the marginal propensities to consume between 2020 and 2050	By 2050 CR results in a reduction in marginal propensities of about 11.7% and a relevant reductions in emissions and increase in unemployment due to the fall in private consumption	----	--	++	+	+++
XR	Yearly reduction of 0.1% in exports between 2020 and 2050	Effects are similar to CR but weaker. XR serves mostly to contain an undesired increase in emissions from CR due to internal price reduction which favours exports	--	-	+	+	+++
WTax	Introduces a wealth tax whose rate increases in proportion to the increase in average propensities to save due to CR + XR	The increase in wealth tax rates, up to about 1.5%, helps contain the increase in deficit-to-GDP ratio that follows CR and XR	~ 0	~ 0	~ 0	-	-

The effects of each policy on selected indicators is represented by + and - which indicate an increase (decrease) in that indicator with respect to the baseline scenario. The signs do not indicate improvement (+) and worsening (-) of the indicators, but rather represent a numerical increase or decrease. The symbol ~ 0 represents a negligible effect on the indicator.

Supplementary Table 20: Summary of Policy Mixes

Scenario	Green Growth	Policies for Social Equity	Degrowth
<b>Policy Mix</b>	HLP + HEEF + EnM + CBA	HEEF + EnM + CBA + JG + WTR	HEEF + EnM + CBA + JG + WTR + CR + XR + WTax
<b>Comment</b>	The main difference with respect to baseline is the reduction in GHG due to <i>EnM</i> . Improved fiscal performance comes at the cost of unemployment and inequality increases.	Sustains a GHG reduction similar to GG while avoiding increases in unemployment and inequality though at a higher fiscal cost.	Similar social results with respect to PSE. However, consumption reduction allows further GHG reduction while increased wealth tax mitigates the fiscal cost of a decreasing GDP.
<b>GDP</b>	-	+	- - -
<b>Emissions</b>	--	--	-- --
<b>Unemployment</b>	+	- - -	--
<b>Inequality</b>	+	--	-- --
<b>Deficit</b>	-	++	+ + +

The effects of each policy mix on selected indicators are represented by + and – which indicate a numerical increase (decrease) of that indicator with respect to the baseline scenario. Whereas improvements (worsening) are marked in blue (red). The precise indicators listed above are: real per capita GDP (GDP), greenhouse gas emissions (Emissions), general unemployment rate (Unemployment), the gini coefficient (Inequality) and government’s deficit-to-GDP ratio (Deficit).

We opted for the *Job Guarantee* instead of *Basic Income (BI)* as part of the *PSE* and *DG* policy-mixes because the former directly faces the problem of unemployment and seems to perform better than the latter on its own with long-lasting effects on employment and distribution due to the continued hiring of workers into the program.

## 2.2 Individual policy results

This subsection provides a graphical representation of the main dynamics characterising each individual policy. Supplementary Figure 13 plots the effects of these individual policies on the main economic variables, while Supplementary Figure 14 shows the socio-environmental consequences. Each line represent the average over 500 simulation runs for each policy.

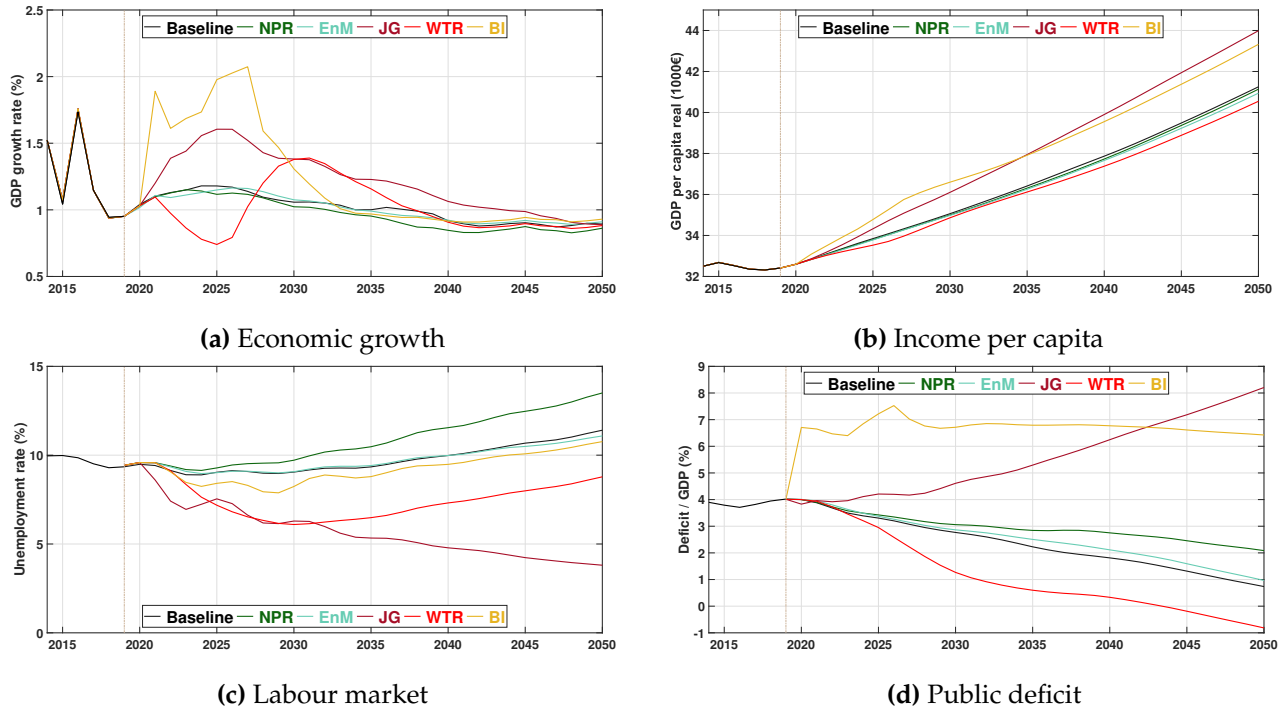

Supplementary Figure 13: Scenario analysis: socio-economic indicators

Comparison – from 2014 to 2050 – of the GDP growth rate (top-left), GDP per capita (top-right), unemployment rate (bottom-left), and deficit-to-GDP ratio (bottom-right) under the baseline (black) compared with five individual policies: *NPR* (dark green), *EnM* (light green), *JG* (dark red), *WTR* (light red), and *BI* (yellow). *NPT* stands for Next Productive Revolution and describes the effect of the joint introduction of *HLP* and *HEEF* policies. The vertical dotted line indicates the introduction of all the policies.

Supplementary Figure 15 shows the distribution of primary energy sources in the electricity generation and in the *TPES* comparing the baseline with the change in energy mix simulated under the *EnM* policy. The two top panels (*a* and *b*) plot the projected trajectories of the five primary energy sources as a percentage of electricity generation. The two bottom panels (*c* and *d*) plot the resource shares in the *TPES*. The combination of the *EnM* with *electrification* leads to a gradual and significant substitution of renewable sources for nuclear energy. The former increases up to about the 50% in 2050, while the second falls from 43.4% to 17.4%.

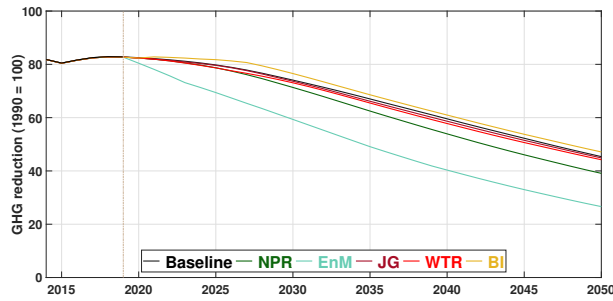

(a) GHG emissions

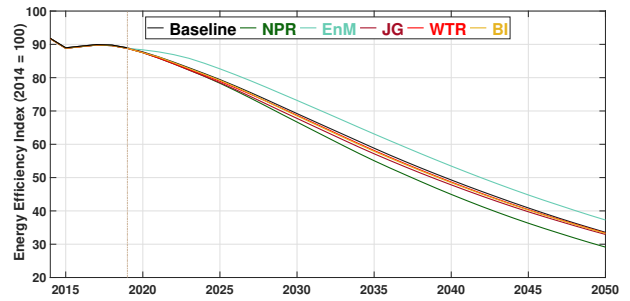

(b) Energy efficiency (TPES/GDP)

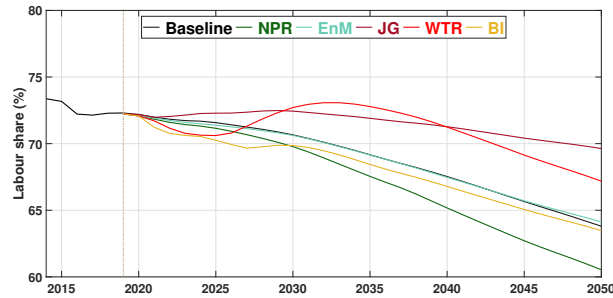

(c) Labour share

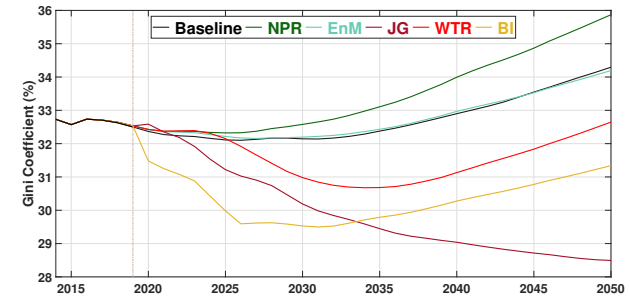

(d) Income inequality

**Supplementary Figure 14: Scenario analysis: socio-environmental indicators**

Comparison – from 2014 to 2050 – of the GHG emission reductions (top-left), energy efficiency (top-right), labour share (bottom), and Gini index (bottom-right) under the baseline (black) compared with five individual policies: *NPR* (dark green), *EnM* (light green), *JG* (dark red), *WTR* (light red), and *BI* (yellow). The vertical dotted line indicates the year in which policy-mixes are introduced (i.e., 2019).

## 2.2.1 Baseline comparison

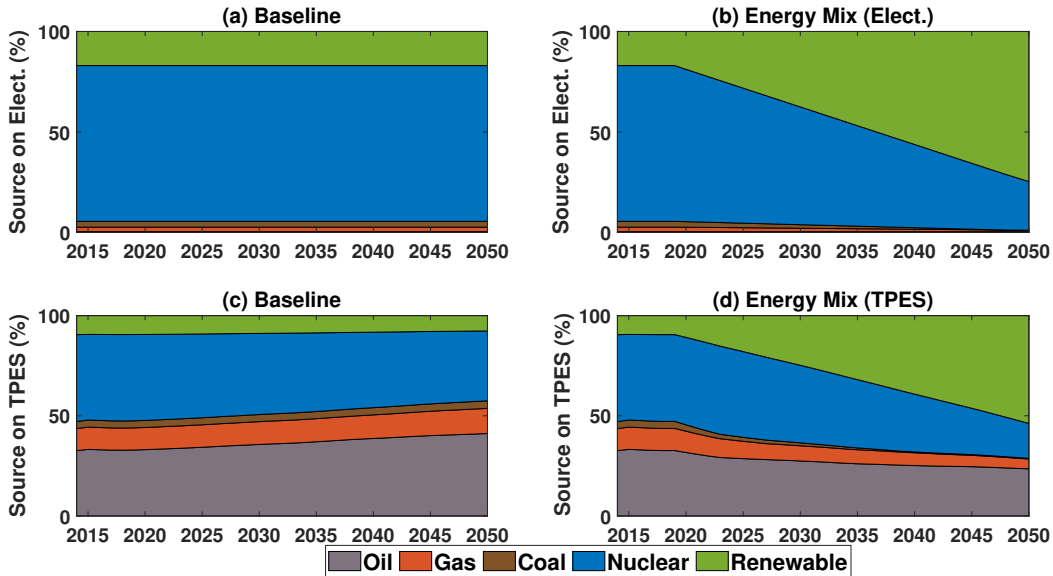

Supplementary Figure 15: Share of energy sources

Dynamic of the distribution of primary energy sources – oil (grey), gas (orange), coal (brown), nuclear (blue) and renewable (green) – in electricity production (panels a and b) and in *TPES* (panels c and d). Comparison of the baseline scenario (panels a and c) with the Energy Mix (*EnM*) policy alone (panels b and d). Panel b plots the effects of *EnM* on the sources used for electricity production. Panel d presents the increased use of renewable sources, from electricity production, in the *TPES* due to the electrification process modelled when *EnM* is simulated.

As a robustness check, Supplementary Table 21 compares six selected variables from our baseline scenario with those projected by the official ‘EU Reference Scenario 2016’ (Capros et al., 2016) and ‘The 2018 Ageing Report’ (European Commission directorate-general for economic and financial affairs, 2017). The outcomes of our baseline scenario are in line with the official EU forecasts, with significant divergences only after 2040. In particular, our baseline scenario presents significantly lower projected GDP growth by 2040 and 2050, which translates into lower GHG emissions and higher unemployment.



**Supplementary Table 21: Selected indicators from the Eurogreen baseline scenario and EU long-term projections**

Selected Indicators	2016	2020	2030	2040	2050
Unemployment rate (15-64)	9.9%	9.5%	9.0%	9.9%	11.4%
	<i>10.2%</i>	<i>9.3%</i>	<i>8.5%</i>	<i>8.2%</i>	<i>7.9%</i>
labour force participation rate (age 15-64)	71.3%	72.4%	73.8%	73.4%	70.8%
	<i>71.2%</i>	<i>71.7%</i>	<i>72.9%</i>	<i>73.9%</i>	<i>74.3%</i>
labour-productivity growth rate (yearly average)	0.6%	1.1%	1.2%	1.4%	1.5%
	<i>0.7%</i>	<i>0.9%</i>	<i>1.0%</i>	<i>1.4%</i>	<i>1.5%</i>
Employment (millions)	26.3	26.9	27.7	27.1	25.7
	<i>26.7</i>	<i>27.2</i>	<i>27.7</i>	<i>28.1</i>	<i>29.0</i>
GDP growth rate (yearly average)	1.2%	1.0%	1.0%	0.99%	0.98%
	<i>1.1%</i>	<i>1.1%</i>	<i>1.2%</i>	<i>1.7%</i>	<i>1.9%</i>
Total GHG emissions* (Mtoe CO <sub>2</sub> equivalent)		432.1	387.7	311.8	237.5
		<i>444.6</i>	<i>392.0</i>	<i>381.9</i>	<i>362.5</i>

Comparison of the forecasts from the baseline scenario as simulated in the Eurogreen model (black) and in the EU official reports 'EU Reference Scenario 2016' (Capros et al., 2016) – variable marked by \* – and 'The 2018 Ageing Report' (European Commission directorate-general for economic and financial affairs, 2017) (blue/italic).

## Supplementary References

- Brainard, W. C. and J. Tobin (1968). Pitfalls in financial model building. *The American Economic Review* 58(2), 99–122.
- Brochier, L. and A. C. M. e. Silva (2018). A supermultiplier stock-flow consistent model: the return of the paradoxes of thrift and costs in the long run? *Cambridge Journal of Economics* 43(2), 413–442.
- Browne, J. and H. Immervoll (2017). Basic income as a policy option: Technical background note illustrating costs and distributional implications for selected countries. Technical report, OECD Directorate of Employment, Labour and Social Affairs, Jobs and Income .
- Capros, P., A. De Vita, N. Tasios, P. Siskos, M. Kannavou, A. Petropoulos, S. Evangelopoulou, M. Zampara, D. Papadopoulos, C. Nakos, et al. (2016). EU Reference Scenario 2016-Energy, transport and GHG emissions Trends to 2050. Technical report, European Commission Directorate-General for Energy, Directorate-General for Climate Action and Directorate-General for Mobility and Transport.
- Christensen, C. M., H. Baumann, R. Ruggles, and T. M. Sadtler (2006). Disruptive innovation for social change. *Harvard Business Review* 84(12), 94.
- Dietzenbacher, E., B. Los, R. Stehrer, M. Timmer, and G. De Vries (2013). The construction of world input–output tables in the WIOD project. *Economic Systems Research* 25(1), 71–98.
- Distefano, T., M. Riccaboni, and G. Marin (2018). Systemic risk in the global water input-output network. *Water resources and Economics* 23, 28–52.
- Engel, C. (2000). Long-run PPP may not hold after all. *Journal of International Economics* 51(2), 243–273.

- European Commission directorate-general for economic and financial affairs (2015b). The 2015 ageing report: Economic and budgetary projections for the eu28 member states (2013-2060). Technical report, E.U.
- European Commission directorate-general for economic and financial affairs (2015a). The 2015 ageing report: Underlying assumptions and projection methodologies. Technical report, E.U.
- European Commission directorate-general for economic and financial affairs (2017). The 2018 ageing report: underlying assumptions and projection methodology. Technical report, European Commission Directorate-General for Economic and Financial Affairs.
- Flood, R. P. and A. K. Rose (2002). Uncovered interest parity in crisis. *IMF staff papers* 49(2), 252–266.
- Freitas, F. and F. Serrano (2015). Growth rate and level effects, the stability of the adjustment of capacity to demand and the Sraffian supermultiplier. *Review of Political Economy* 27(3), 258–281.
- Garbinti, B., J. Goupille-Lebret, and T. Piketty (2017). Accounting for wealth inequality dynamics: Methods, estimates and simulations for france (1800-2014). Technical report, Banque de France Working Paper No. WP 633.
- Girardi, D. and R. Pariboni (2016). Long-run effective demand in the us economy: An empirical test of the sraffian supermultiplier model. *Review of Political Economy* 28(4), 523–544.
- Godley, W. and M. Lavoie (2016). *Monetary economics: an integrated approach to credit, money, income, production and wealth*. Springer.
- Goos, M., A. Manning, and A. Salomons (2009). Job polarization in Europe. *American economic review* 99(2), 58–63.
- Hein, E. (2018). Autonomous government expenditure growth, deficits, debt, and distribution in a neo-kaleckian growth model. *Journal of Post Keynesian Economics* 41(2), 316–338.
- Lavoie, M. (2014). *Post-Keynesian economics: New foundations*. Edward Elgar Publishing.
- Lavoie, M. (2016). Convergence towards the normal rate of capacity utilization in neo-kaleckian models: The role of non-capacity creating autonomous expenditures. *Metroeconomica* 67(1), 172–201.
- Leamer, E. E. (2007). Housing is the business cycle. Technical report, National Bureau of Economic Research.
- Lequiller, F. (2015). Towards convergence between government finance statistics and public sector accounting standards. Technical report, Eurostat review on National Accounts and macroeconomic indicators, ISSN 1977-978X.
- Miller, R. E. and P. D. Blair (2009). *Input-output analysis: Foundations and extensions*. Cambridge University Press.
- Nordhaus, W. D. (2010). Modeling induced innovation in climate-change policy. In *Technological change and the environment*, pp. 188–215. Routledge.
- OECD (2013). Pensions at a glance 2013. Technical report, OECD.
- OECD (2015). Taxing wages 2015. Technical report, OECD.
- Satchell, P. (2018). *Innovation and automation*. Routledge.
- Serrano, F., F. Freitas, and G. Bhering (2019). The trouble with harrod: the fundamental instability of the warranted rate in the light of the sraffian supermultiplier. *Metroeconomica* 70(2), 263–287.
- Spronk, R., W. F. Verschoor, and R. C. Zwinkels (2013). Carry trade and foreign exchange rate puzzles. *European Economic Review* 60, 17–31.

- Toenig, M. and T. Verdier (2003). A theory of defensive skill-biased innovation and globalization. *American Economic Review* 93(3), 709–728.
- Timmer, M. P., E. Dietzenbacher, B. Los, R. Stehrer, and G. J. De Vries (2015). An illustrated user guide to the world input–output database: The case of global automotive production. *Review of International Economics* 23(3), 575–605.
- Tobin, J. (1969). A general equilibrium approach to monetary theory. *Journal of Money, Credit and Banking* 1(1), 15–29.
- Xu, Y. and E. Dietzenbacher (2014). A structural decomposition analysis of the emissions embodied in trade. *Ecological Economics* 101, 10–20.